

Instrukcja montażu
Montageanleitung
Instructions D'assemblage
Assembly instructions
Návod na montáž
Montážni návod
Uputstvo za montažu
Upute za montažu

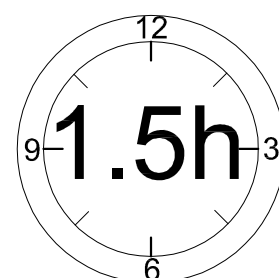

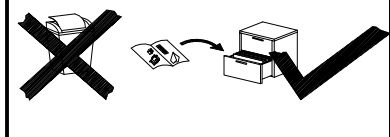
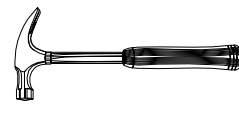
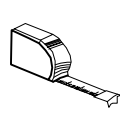
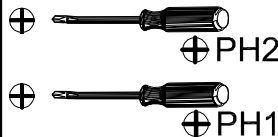
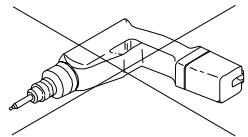

PL: WAŻNE INFORMACJE. Przed użyciem produktu należy dokładnie zapoznać się ze wskazówkami bezpieczeństwa. Należy zapoznać się z instrukcją obsługi i zachować ją do użytku w przyszłości.
GB: IMPORTANT INFORMATION! Please read the entire manual carefully before starting to assemble and/or using this product. Follow the manual thoroughly and keep it for further reference.
FR: INFORMATIONS IMPORTANTES Veuillez lire attentivement l'ensemble du manuel avant de commencer à monter et/ou utiliser ce produit. Suivez rigoureusement le manuel et conservez-le pour toute consultation ultérieure.
SK: DŮLEŽITÉ INFORMÁCIE! Predtým ako začnete s montážou a/alebo používaním tohto produktu si pozorne prečítajte celý návod. Návod dôsledne dodržiavajte a ponechajte si ho prepožitie v budúcnosti
CZ: DŮLEŽITÉ INFORMACE! Před sestavením nebo použitím výrobku si pečlivě přečtěte celý návod. Dodržujte důsledně uvedené pokyny a návod uschovejte, aby byl k dispozici v případě potřeby.
DE: MONTAGEANLEITUNG Bitte lesen Sie die Montageanleitung durch, bevor Sie mit dem Aufbau oder Benutzung beginnen. Folgen Sie den einzelnen Schritten der Anleitung und bewahren Sie auf.
SRB: VAŽNE INFORMACIJE!
Molimo Vas pažljivo pročitajte uputstvo za upotrebu pre sastavljanja i/ili korišćenja ovog proizvoda. Strogo se pridržavajte uputstva i sačuvajte ga za buduće potrebe.
HR: VAŽNE OBAVIJESTI! Molimo Vas pažljivo pročitajte upute za uporabu prije sastavljanja i/ili korištenja ovog proizvoda. Strogo se pridržavajte uputa i sačuvajte ih za buduće potrebe.

PL: OSTRZEŻENIE PRZED WYWRÓCENIEM SIĘ MEBLA. Produkt musi być na stałe przymocowany do ściany dołączonymi uchwytemi, aby uniknąć śmiertelnego wypadku, gdy się wywróci. W pakiecie są tylko śruby pozwalające na przykręcenie uchwytów do produktu, które zapobiegają przewróceniu się produktu. Prosimy o skontaktowanie się ze specjalistycznym sklepem lub fachowcem w sprawie śrub lub kołków, które należy zastosować do danego typu ściany.
GB: ANTI-TOPPLE WARNING! This product has to be permanently fixed to the wall with the bracket(s) included, to avoid fatal injury in case it topples over. The pack contains only screws for fastening the anti-topple bracket(s) itself to the product. Please contact your DIY or hardware store for advice on the correct type of screws/plugs for your type of wall.
FR: AVERTISSEMENT ANTIBASCULEMENT Ce produit doit être fixé de manière permanente au mur à l'aide du/des support(s) inclus afin d'éviter des blessures mortelles en cas de basculement. L'emballage contient des vis pour attacher le(s) support(s) antibasculement au produit. Veuillez contacter votre magasin de bricolage ou votre quincaillerie pour obtenir des conseils sur le type de vis/chevilles adapté à votre mur.
CZ: VAROVÁNÍ TYKAJÍCÍ SE SKLOPENÍ! Tento výrobek musí být trvale připevněn na stěnu pomocí přiložených držáků, aby nedošlo ke smrtelnému zranění, kdyby se sklopil. Sada obsahuje pouze šroubky pro upevnění držáků zabraňujících sklopení k výrobku. Ohledně správného typu vrutů/hmoždinek pro daný typ stěny se obraťte na vhodný obchod nebo železářství.
SK: VÝSTRAHA PRED PREVRÁTENÍM! Tento produkt musí byť natrvalo pripevnený k stene pomocou dodanej(-ých) konzoly (konzol), aby sa predišlo smrtelnému úrazu v prípade, že sa prevráti. Balenie obsahuje iba skrutky, ktorými sa pripevňujú k produktu samotné konzoly chrániace pred prevrátaním. Kontaktujte miestnu predajňu pre domácich majstrov alebo železiarstvo, kde vám poradia ohľadom správneho typu skrutiek/prichytiiek pre váš typ steny.
DE: KIPPSICHERUNG Dieses Produkt muss ständig an der Wand mit der beigefügten Klammer befestigt werden. Um geeigneten Dübel und Schrauben zu verwenden fragen Sie bitte einen Fachmann nach.
SRB: UPOZORENJE O ZAŠTITI OD PREVRTANJA! Proizvod mora biti trajno pričvršćen za zid pomoću isporučениh nosača kako bi se u slučaju prevrtanja proizvoda izbegle smrtonosne povrede. Sa proizvodom se isporučuju samo vijci za pričvršćivanje zaštitnih nosača na proizvod. Molimo Vas da od svog prodavca zatražite savet o vrsti vijaka/tipli koje su najprikladnije za Vaš zid.
HR: UPOZORENJE O ZAŠTITI OD PREVRTANJA! Proizvod mora biti trajno učvršćen na zid s pomoću isporučenih nosača kako bi se u slučaju prevrtanja proizvoda izbegle smrtonosne ozljede. S proizvodom se isporučuju samo vijci za pričvršćivanje zaštitnih nosača na proizvod. Molimo Vas da od svog prodavača zatražite savjet o vrsti vijaka/tipli koje su najprikladnije za Vaš zid.

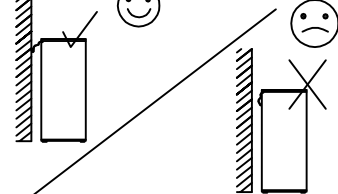
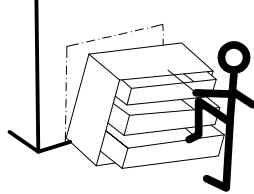
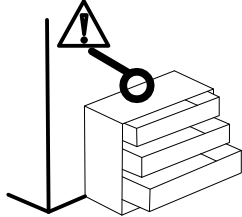

PL: OSTRZEŻENIE WS. USZKODZEŃ Aby uniknąć rys, ten mebel powinien być montowany, składany na miękkim podłożu, np. dywanie.
GB: WARNING TO AVOID SCRATCHES! In order to avoid scratching this furniture should be assembled on a soft layer - could be a rug.
FR: AVERTISSEMENT POUR ÉVITER LES RAYURES Afin d'éviter les rayures, ce meuble doit être monté sur une surface souple (un tapis, par exemple).
CZ: VAROVANI TYKAJICI SE POSKRABANI! Aby nedošlo k poskrabani, sestavujte nabytek na mekkem podkladu - napr. na koberci.
SK: VÝSTRAHA TYKAJUČA SA PREDCHADZANIA SKRABANCOM! Aby sa predišlo skrabancom, tento nabytok by mal montovať na nakkom podklade, napríklad na koberci.
DE: WARNUNG GEGEN BESCHÄDIGUNGEN Um die Kratzer zu beseitigen, legen Sie bitte die Elemente auf einem weichen Boden, z.B. Teppich.
SRB: UPOZORENJE O IZBEGAVANJU OGREBOTINA! Kako bi se izbegle ogrebotine ovaj proizvod je potrebno sastavljati na mekanoj površini-na primer, na tepihu.
HR: UPOZORENJE O IZBJEGAVANJU OGREBOTINA! Kako bi se izbegle ogrebotine, ovaj proizvod potrebno je sastavljati na mekanoj površini-na primjerice, na tepihu.

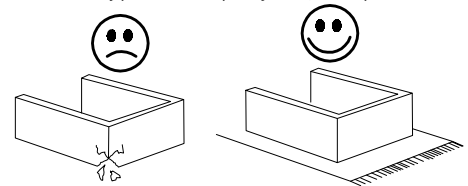

PL: OGÓLNE INSTRUKCJE DOTYCZĄCE MEBLI Z DREWNA ORAZ MATERIAŁÓW DREWNOPOCHODNYCH: MELAMINA, LAMINAT, OKLEINA Do czyszczenia należy używać wilgotnej ściereczki. Używać wyłącznie wody lub delikatnego detergentu. Wycierać do sucha ściereczką.
GB: GENERAL INSTRUCTION FOR FURNITURE MADE OF WOOD OR WOOD COMPOSITES SUCH AS MELAMINE, LAMINATE OR VENEER SURFACES Wipe clean with a damp cloth. Use only water or a gentle detergent. Wipe dry with a clean cloth.
FR: INSTRUCTIONS GÉNÉRALES POUR LE MOBILIER CONSTITUÉ DE BOIS OU DE COMPOSITES DE BOIS (COMME LES SURFACES EN MELAMINÉ, STRATIFIÉ OU PLACAGE) Nettoyer à l'aide d'un chiffon humide. Utiliser uniquement de l'eau ou un détergent doux. Essuyer à l'aide d'un chiffon propre.
CZ: OBECNÉ POKYNY TYKAJÍCÍ SE NÁBYTKU VYROBENÉHO ZE DŘEVA NEBO Z KOMPOZITŮ DŘEVA, NAPŘ. S POVRCHEM Z MELAMINU, LAMINÁTU NEBO DÝHY! Čistíte otřením navlhčeným hadříkem. Používejte pouze vodu nebo jemný čistič prostředek. Vytřete dosucha čistým hadříkem.
SK: VŠEOBECNÉ POKYNY PRE NÁBYTOK VYROBENÝ Z DREVA ALEBO KOMPOZITNÝCH MATERIÁLOV, NAPRIKAD MELAMINU, LAMINÁTU ALEBO PREGLEJKOVÝCH POVRCHOV! Utrite dočista navlhčenou utierkou. Používajte iba vodu alebo jemný čistiaci prostriedok. Utrite dosucha čistou utierkou.
DE: ALLGEMEINE ANWEISUNGEN FÜR REINIGUNG DES HOLZES UND HOLZÄHNLICHEN PRODUKTEN: MELAMIN, LAMINAT, BESCHICHTUNG Zur Möbelreinigung verwenden Sie ein mit Wasser oder Feinwaschmittel befeuchtetes, Baumwolltuch. Gereinigte Flächen immer trockenreiben!
SRB: OPŠTE UPUTSTVO ZA NAMEŠTAJ IZRAĐEN OD DRVETA ILI DRVNIH KOMPOZITA, KAO ŠTO SU POVRŠINE OD MELAMINA, LAMINATA ILI FURNIRA! Očistiti vlažnom krpom. Upotrebljavati samo vodu ili blagi deterdžent. Posušiti čistom krpom.
HR: OPĆE UPUTE ZA NAMJEŠTAJ IZRAĐEN OD DRVA ILI DRVNIH KOMPOZITA, KAO ŠTO SU POVRŠINE OD MELAMINA, LAMINATA ILI FURNIRA! Očistite vlažnom krpom. Upotrijebite samo vodu ili blagi deterdžent. Posušite čistom krpom.

PL: WAŻNE! Ważne jest, żeby każdy ze skręcanych produktów został ponownie dokręcony w ciągu 2 tygodni od montażu, a następnie sprawdzac co 3 miesiące czy śruby są dokręcone – w celu zapewnienia stabilności przez czas użytkowania produktu .
GB: IMPORTANT! It is important that any product which is assembled using any kind of screw is re-tightened 2 weeks after assembly, and once every 3 months - in order to assure stability through-out the lifespan of the product.
FR: IMPORTANT Il est important que tout produit monté à l'aide de vis soit resserré 2 semaines après son montage, puis tous les 3 mois, afin de garantir sa stabilité durant tout son cycle de vie.
CZ:DŮLEŽITÉ! U každého výrobku, který se sestavuje pomocí jakýchkoli šroubků, je důležité dotáhnout šroubky 2 týdny po sestavení a potom každé 3 měsíce, aby byla zajištěna stabilita po celou dobu životnosti výrobku.
SK:DŮLEŽITÉ! Je dôležité, aby sa na akomkoľvek produkte, montovanom pomocou akýchkoľvek skrutiek, skrutky dotiahli po dvoch týždňoch od montáže, a jedenkrát v priebehu každých 3 mesiacov - tak sa zaručí stabilita počas celej životnosti produktu.
DE: WICHTIG! Es ist sehr wichtig ca. 2 Wochen nach der Montage alle Befestigungen zu überprüfen und dieses Vorgehen jede 3 Monate zu wiederholen, um Lebensdauer des Möbels zu verlängern.
SRB: VAŽNO! Važno je da se svi tipovi vijaka na bilo kojoj vrsti proizvoda koji se pomoću njih sastavlja ponovo pritegnu 2 nedelje nakon sastavljanja kao i jednom svaka 3 meseca-kako bi se osigurala stabilnost tokom životnog veka proizvoda.
HR: VAŽNO! Važno je da se svi tipovi vijaka na bilo kojoj vrsti proizvoda koji se s pomoću njih sastavlja ponovo pritegnu 2 tjedna nakon sastavljanja te jednom svaka 3 mjeseca-kako bi se zajamčila stabilnost tijekom životnog vijeka proizvoda.

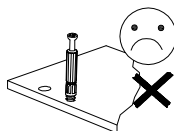
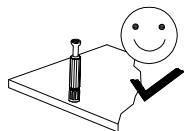

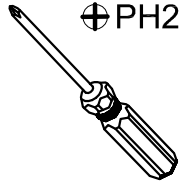
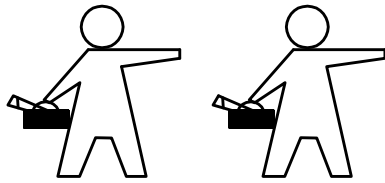



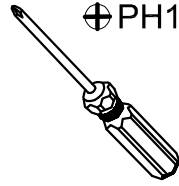



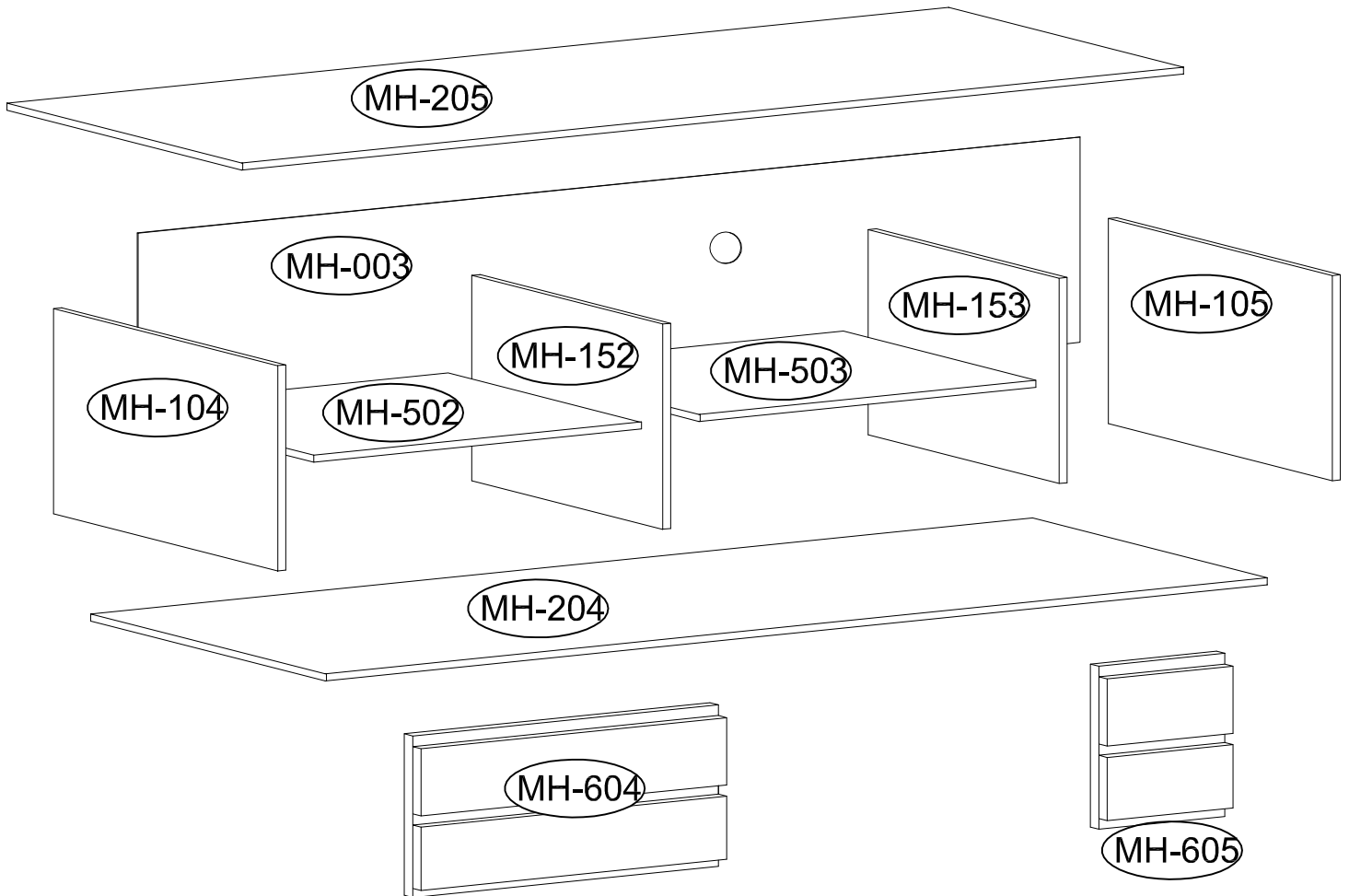
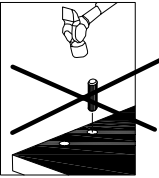
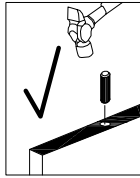
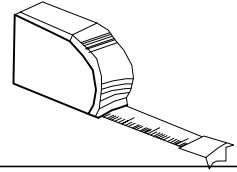

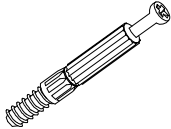
⊕PH2

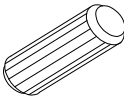
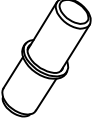

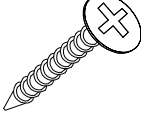
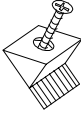
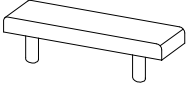
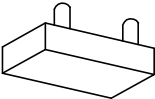
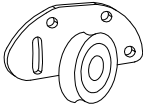
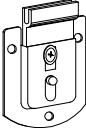
⊕PH1

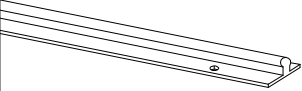

<p>4066</p>  <p>Ø6.5x36.5mm x16</p>	<p>3996</p>  <p>Ø15x16mm x16</p>	<p>136236</p>  <p>Ø20 x16</p>	<p>3989</p>  <p>Ø8x30mm x16</p>
<p>4017</p>  <p>x8</p>	<p>3879</p>  <p>Ø6.3x13mm x4</p>	<p>3923</p>  <p>Ø4,0x16mm x28</p>	<p>4044</p>  <p>x12</p>
<p>4057</p>  <p>x8</p>	<p>IN01112</p>  <p>H-20 mm x2</p>	<p>IN01007</p>  <p>x4</p>	<p>IN01006</p>  <p>x4</p>
<p>30585</p>  <p>x1</p>	<p>83658</p>  <p>x2</p>	<p>3912</p>  <p>Ø3,0x13mm x10</p>	

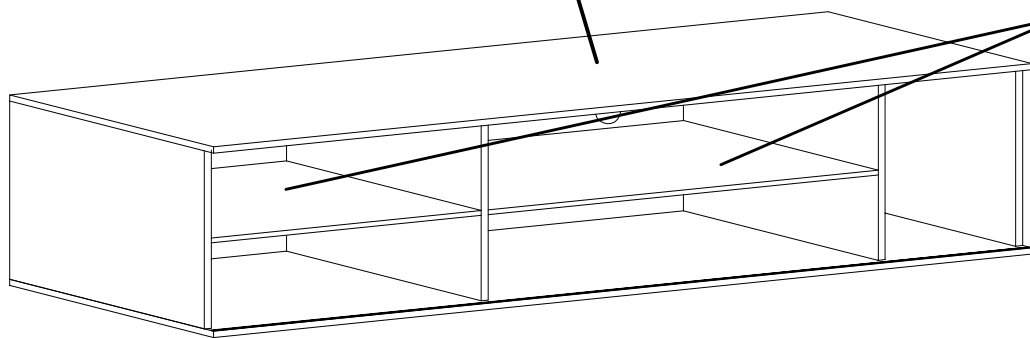
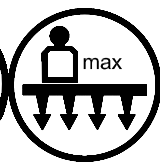
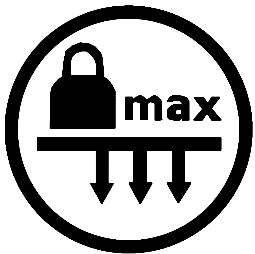

1

4057

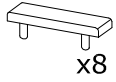

x8

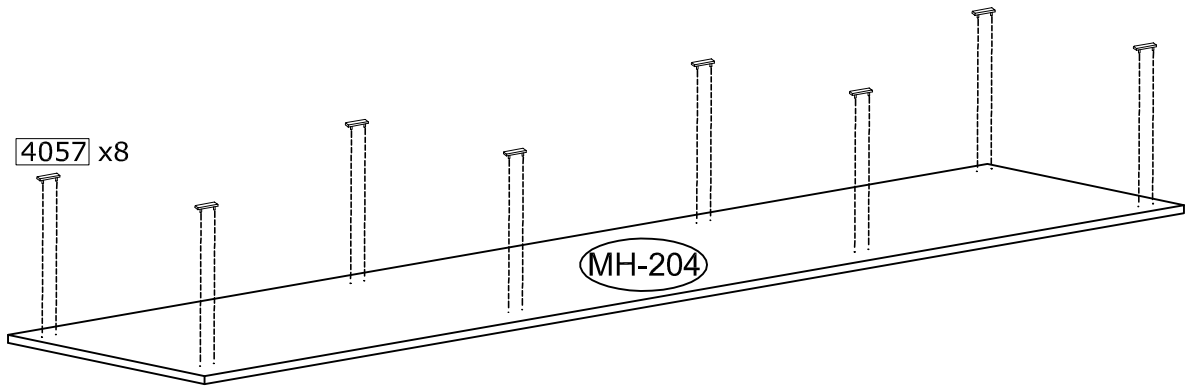
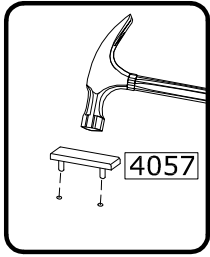

2

4066



x8

83658



x1

3912



3,0X13 x5

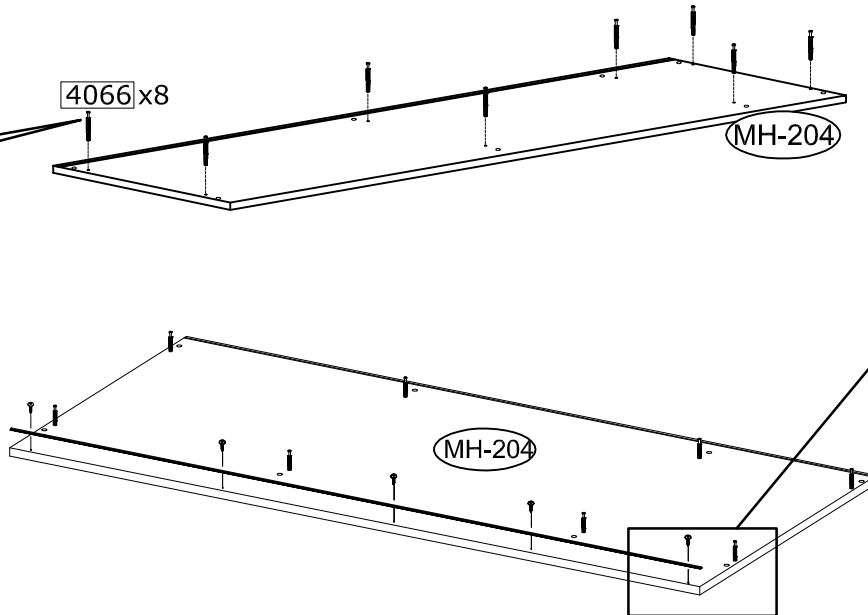
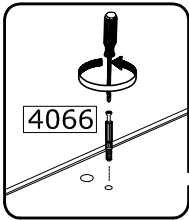

3

4017



W-2

3989



Dx8

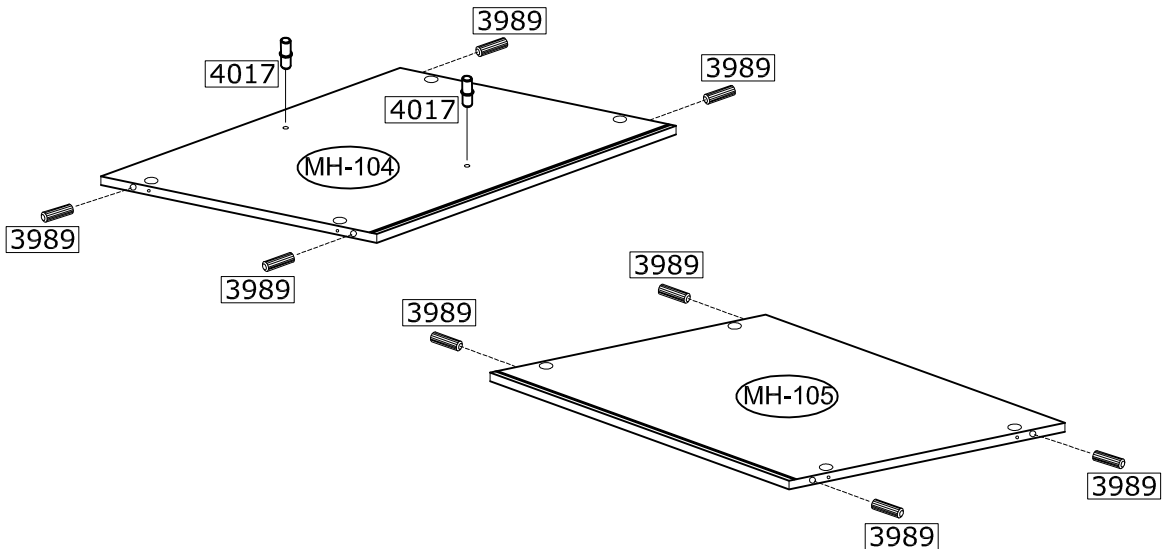
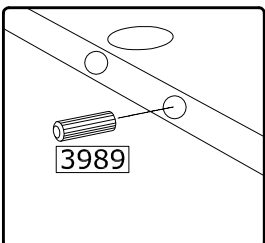
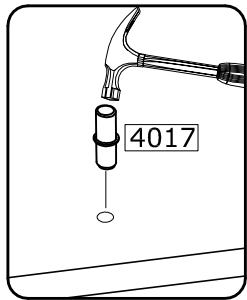

4

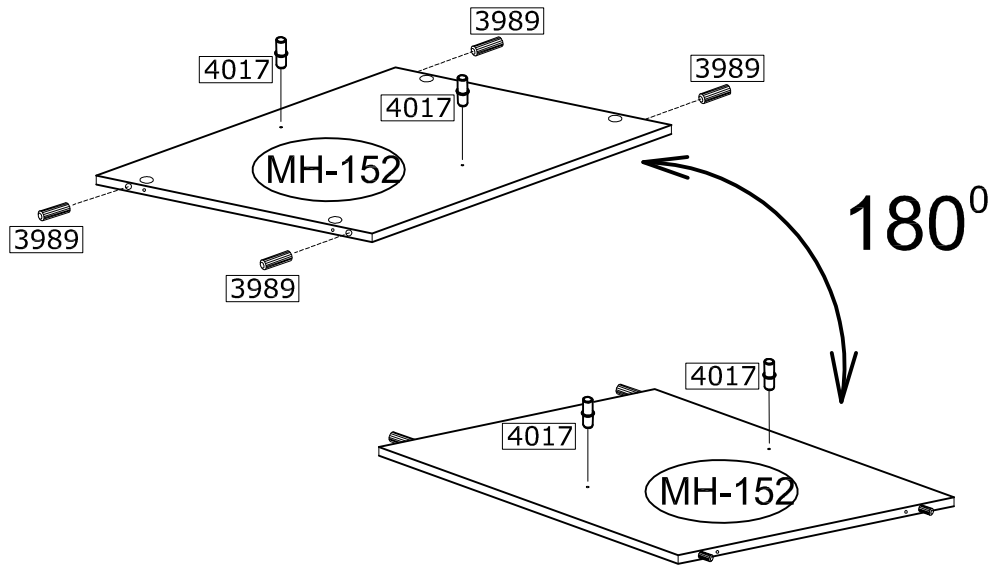
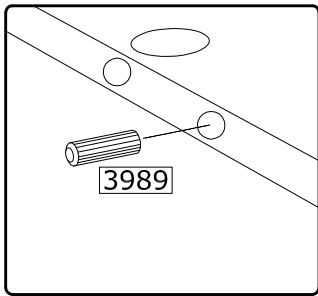
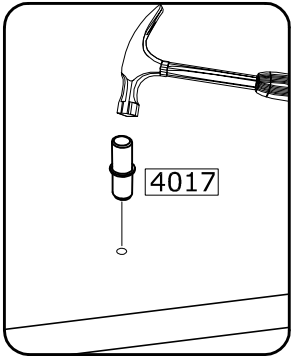
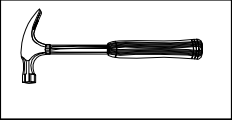
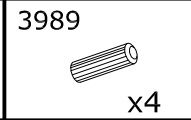
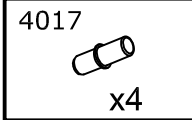

5

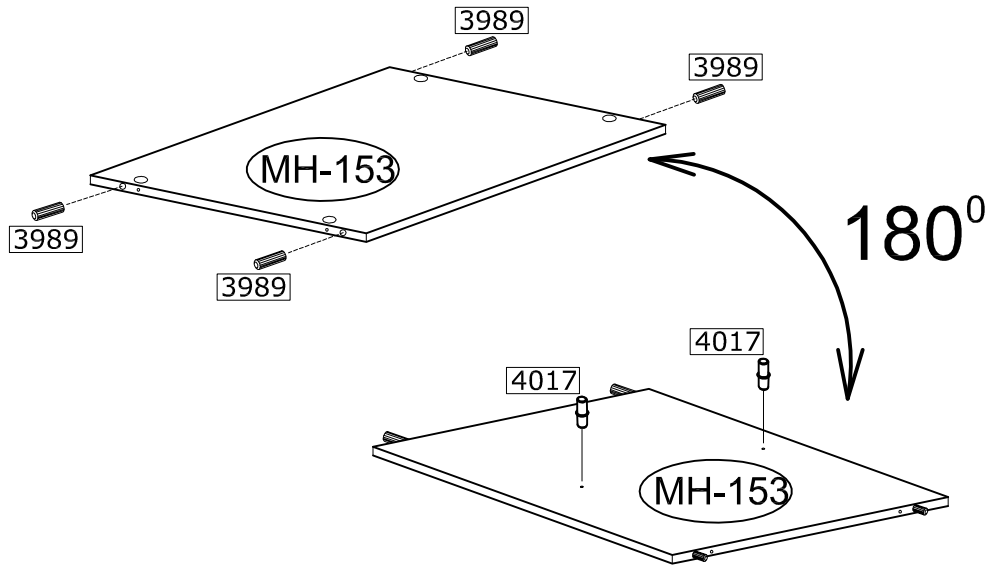
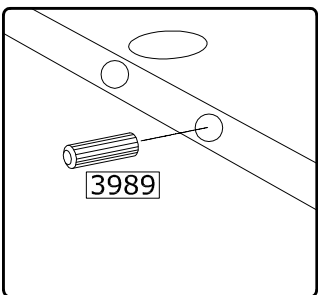
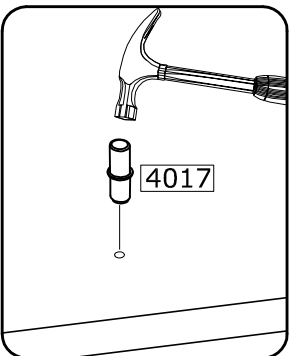
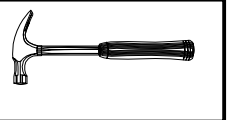
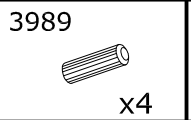

6

4066  x8	83658  x1	3912  3,0X13 x5	
--	---	---	--

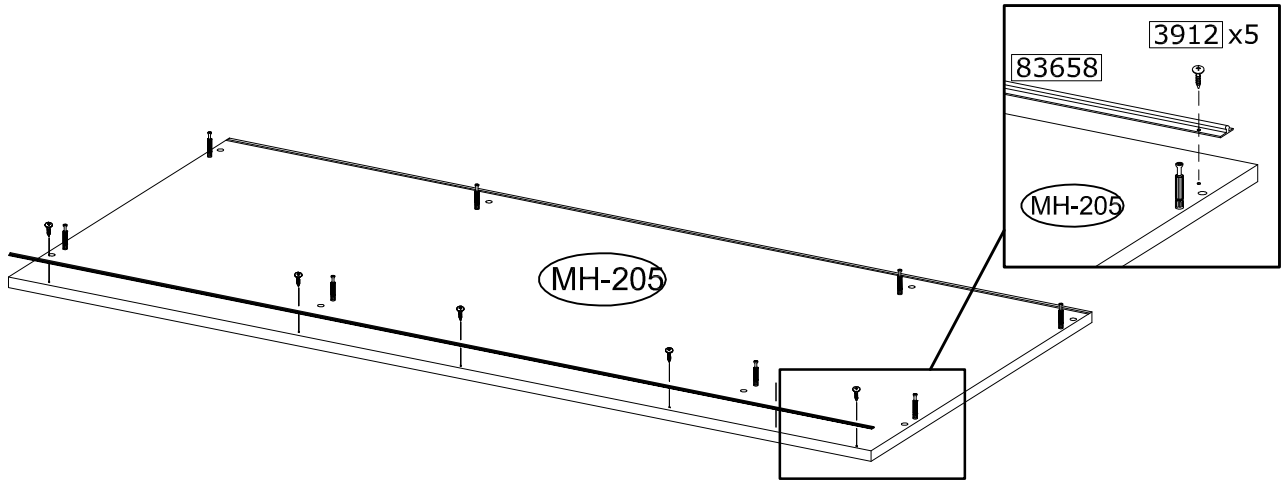
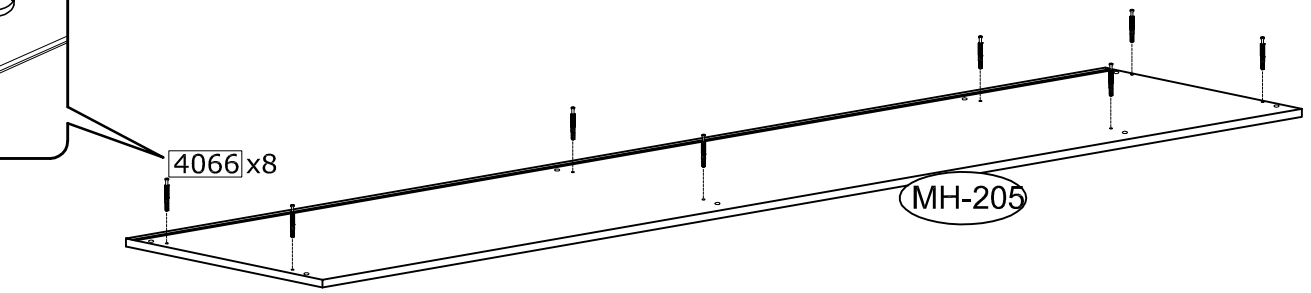
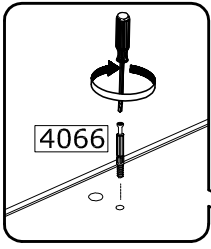

7

3996  x8	136236  x8		
---	---	--	---

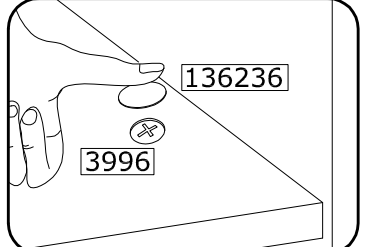
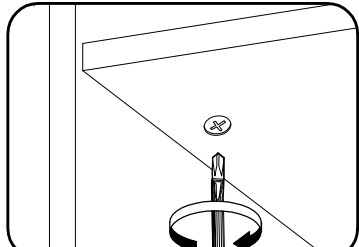
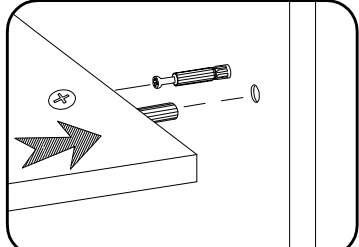
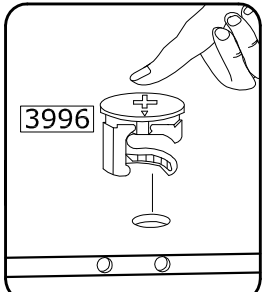
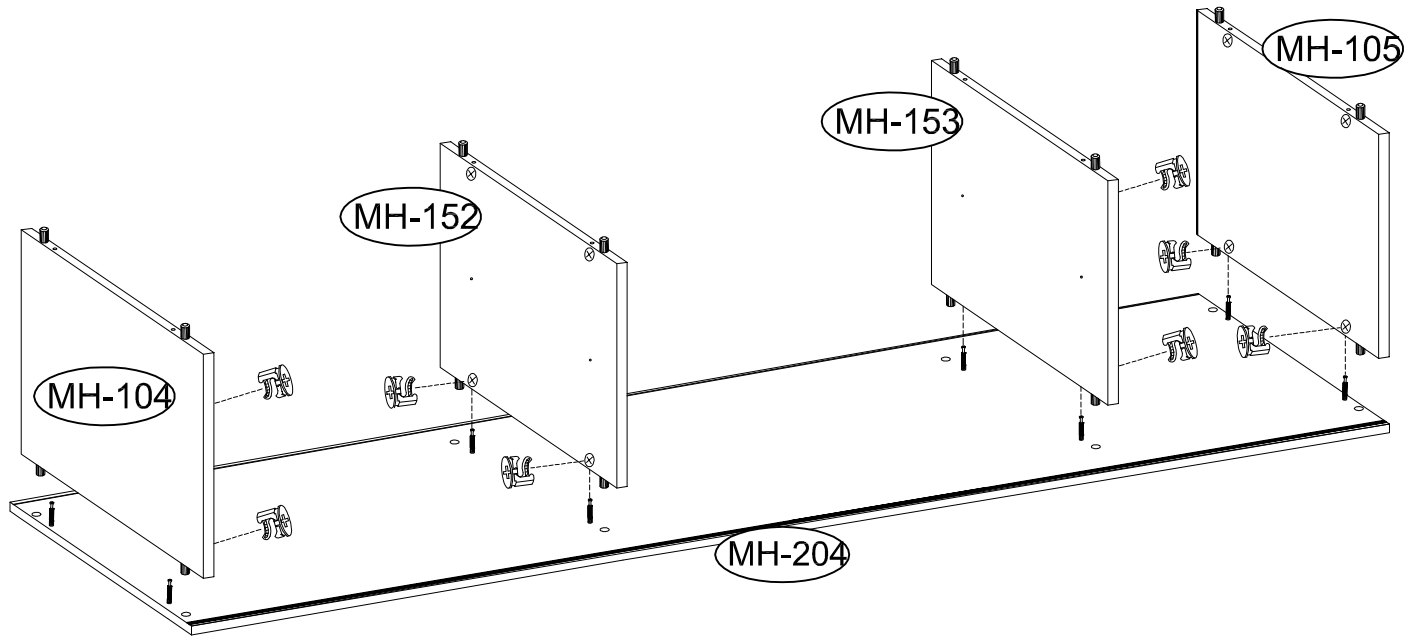

8

30585



x1

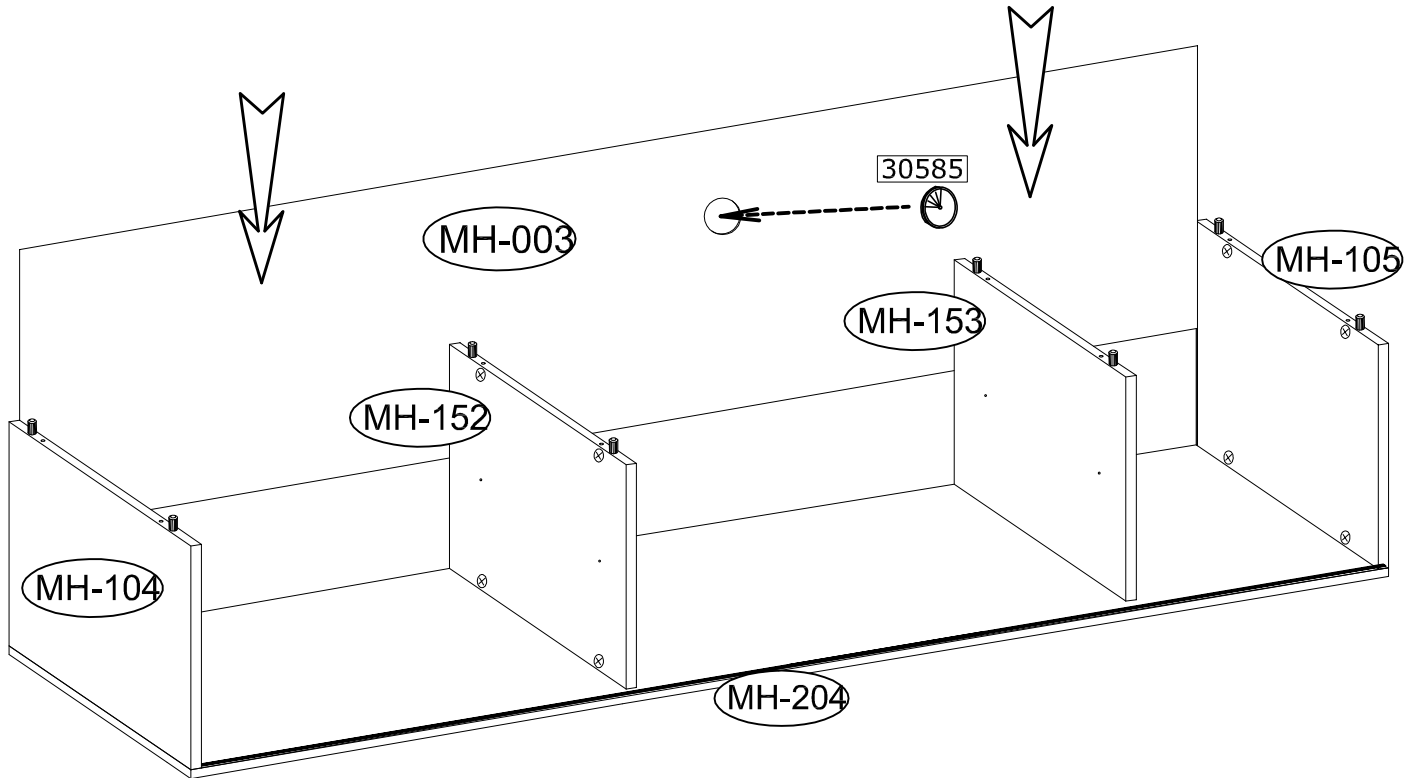

9

3996



x8

136236



x8

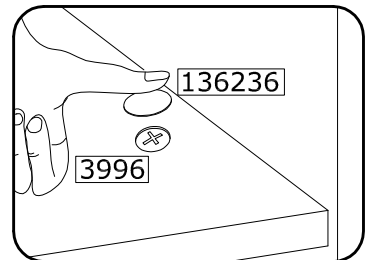
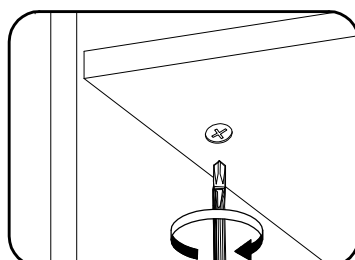
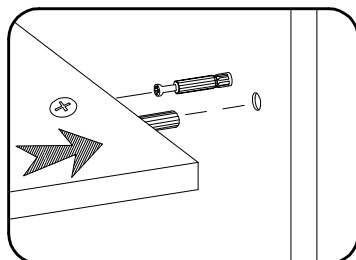
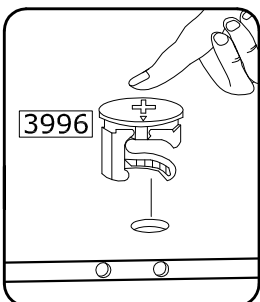
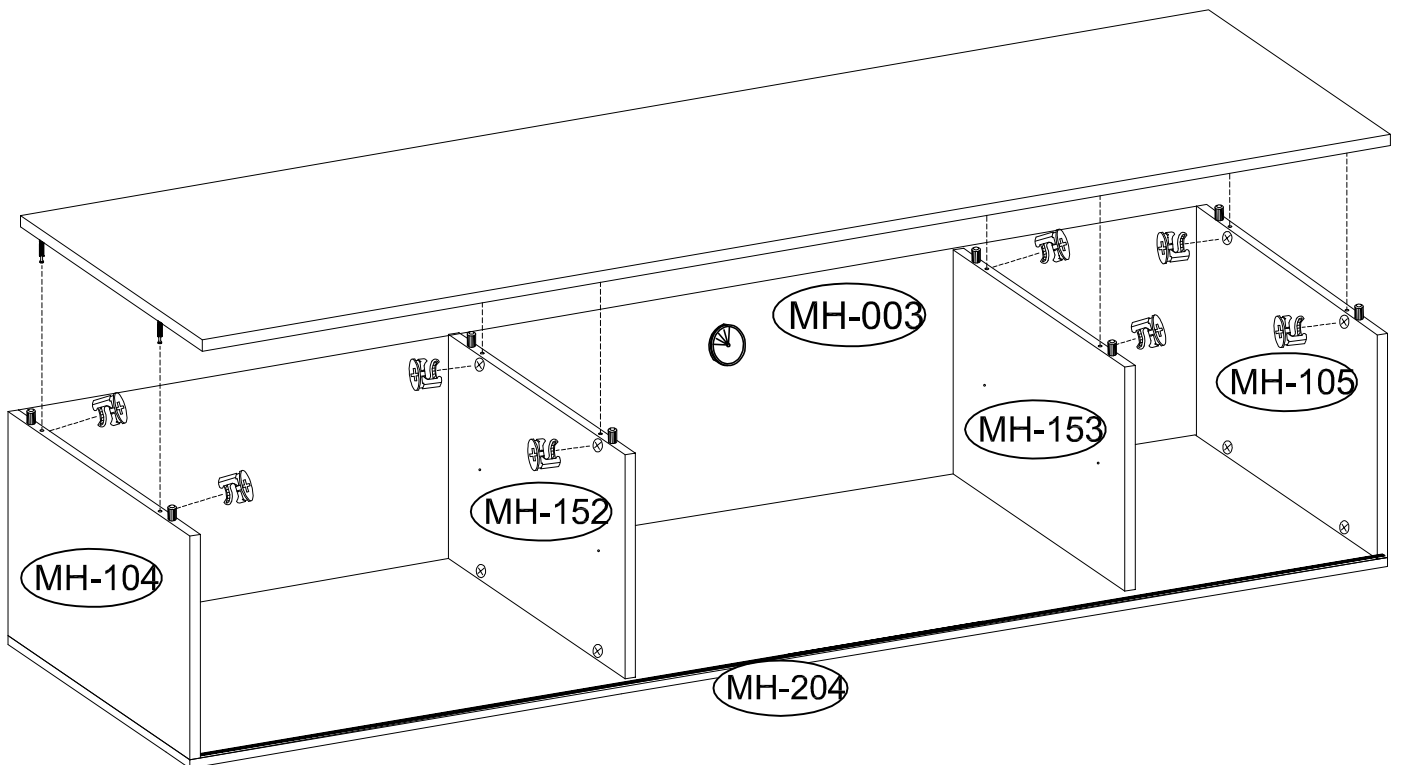

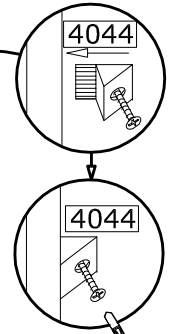
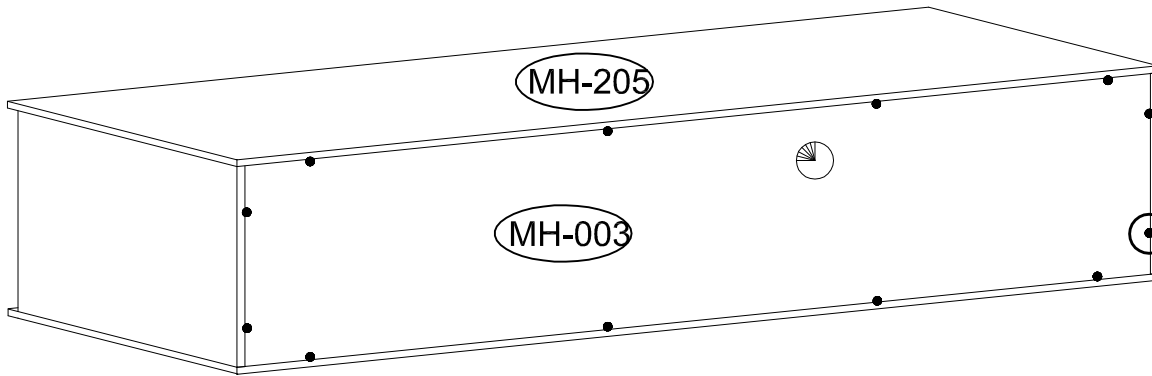
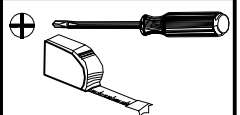

10

4044
 x12



11

IN01006
 x2

IN01007
 x2

3923
 x8

3879
 x2

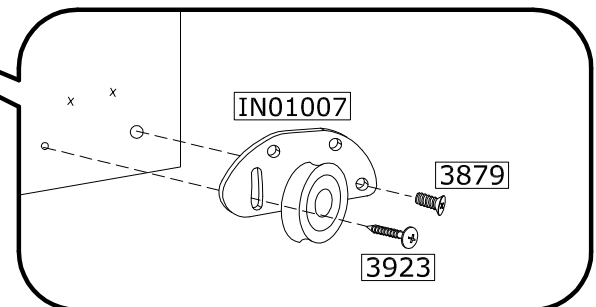
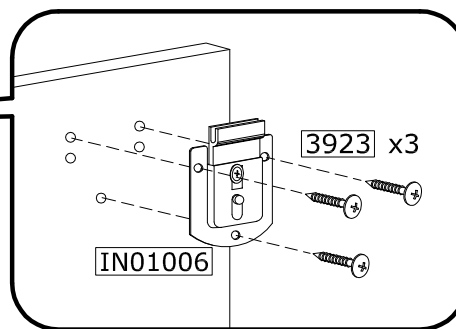
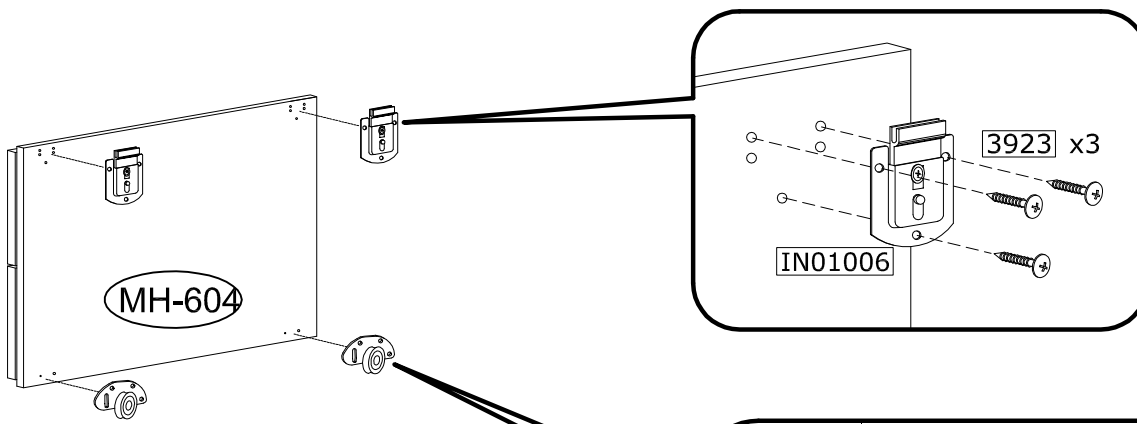
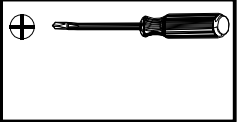

12

IN01007
x2

IN01007
x2

3923
x8

3879
x2

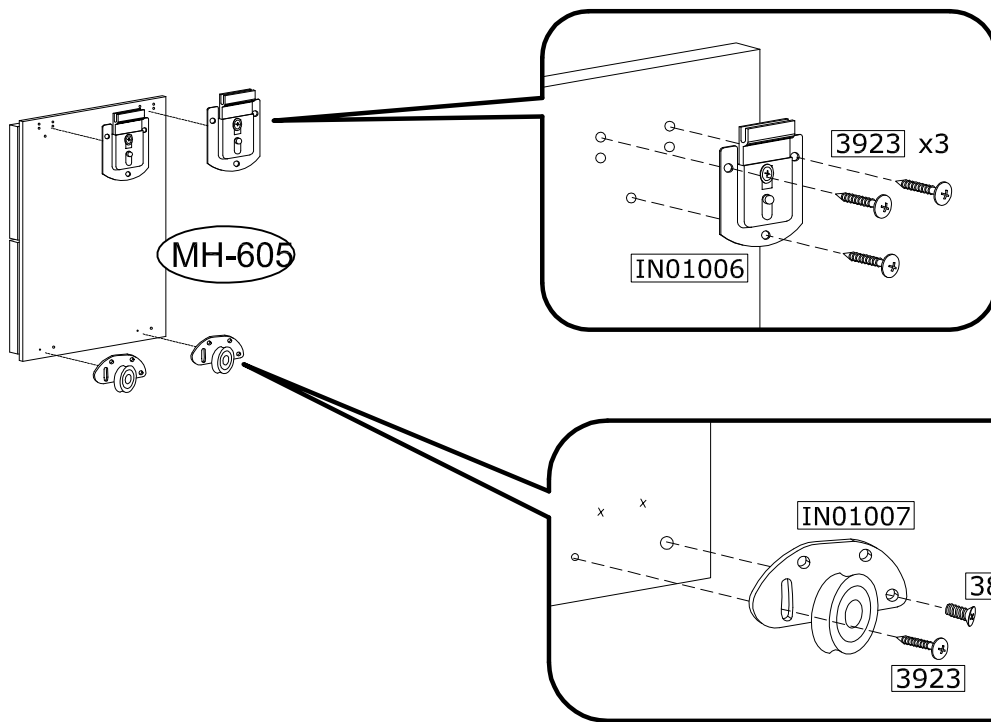

13

IN01112
x2

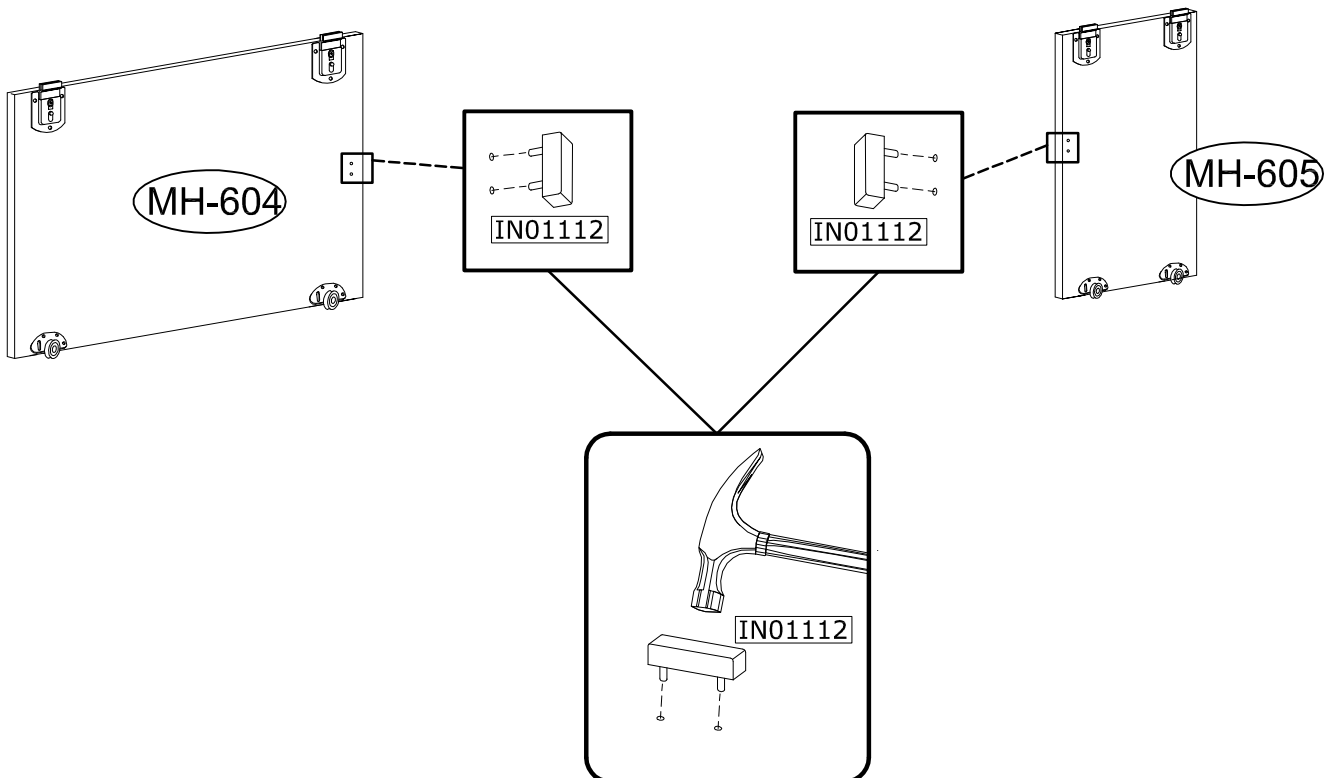

14

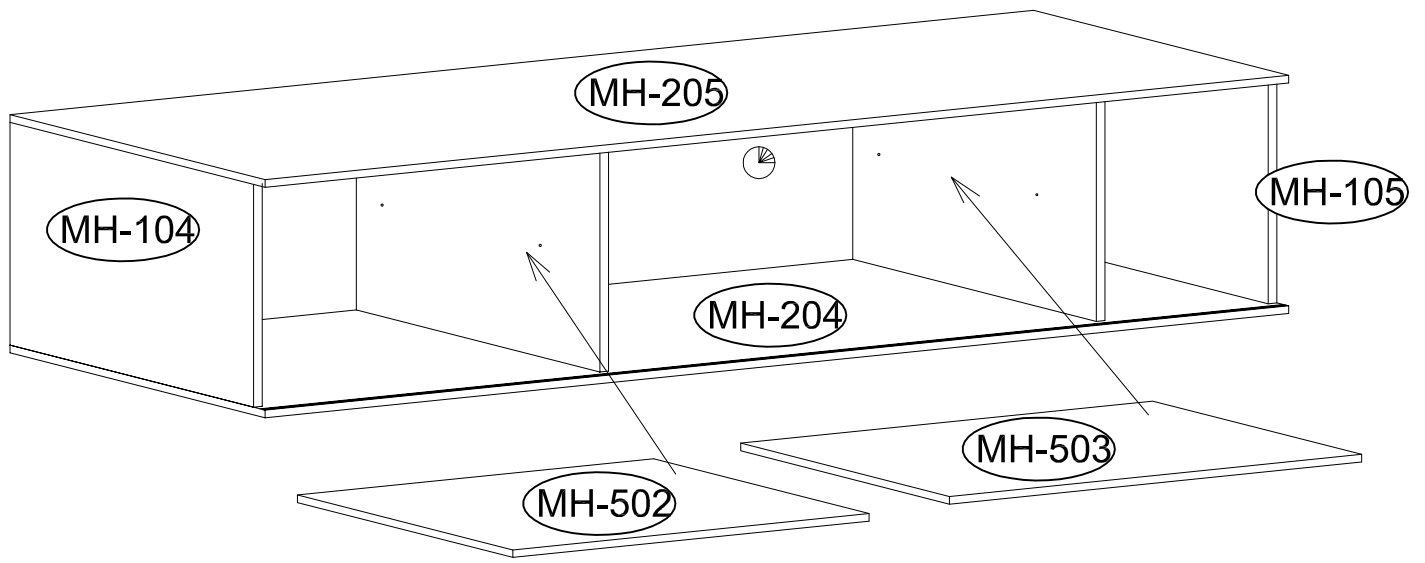

15

3923



x8

