

Instrukcja montażu
Montageanleitung
Instructions D'assemblage
Assembly instructions
Návod na montáž
Montážni návod
Uputstvo za montažu
Upute za montažu

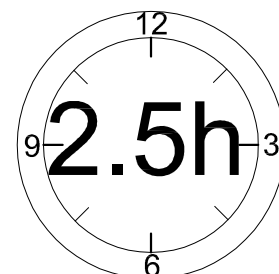

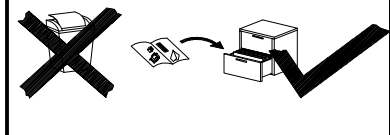
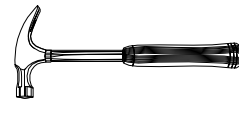
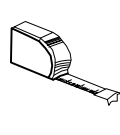
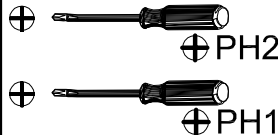
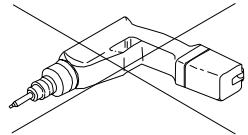

PL: WAŻNE INFORMACJE. Przed użyciem produktu należy dokładnie zapoznać się ze wskazówkami bezpieczeństwa. Należy zapoznać się z instrukcją obsługi i zachować ją do użytku w przyszłości.
 GB: IMPORTANT INFORMATION! Please read the entire manual carefully before starting to assemble and/or using this product. Follow the manual thoroughly and keep it for further reference.
 FR: INFORMATIONS IMPORTANTES Veuillez lire attentivement l'ensemble du manuel avant de commencer à monter et/ou utiliser ce produit. Suivez rigoureusement le manuel et conservez-le pour toute consultation ultérieure.
 SK: DÔLEŽITÉ INFORMÁCIE! Predtým ako začnete s montážou a/alebo používaním tohto produktu si pozorne prečítajte celý návod. Návod dôsledne dodržiavajte a ponechajte si ho prepožitie v budúcnosti
 CZ: DŮLEŽITÉ INFORMACE! Před sestavením nebo použitím výrobku si pečlivě přečtěte celý návod. Dodržujte důsledně uvedené pokyny a návod uschovejte, aby byl k dispozici v případě potřeby.
 DE: MONTAGEANLEITUNG Bitte lesen Sie die Montageanleitung durch, bevor Sie mit dem Aufbau oder Benutzung beginnen. Folgen Sie den einzelnen Schritten der Anleitung und bewahren Sie auf.
 SRB: VAŽNE INFORMACIJE!
 Molimo Vas pažljivo pročitajte uputstvo za upotrebu pre sastavljanja i/ili korišćenja ovog proizvoda. Strogo se pridržavajte uputstva i sačuvajte ga za buduće potrebe.
 HR: VAŽNE OBAVIJESTI! Molimo Vas pažljivo pročitajte upute za uporabu prije sastavljanja i/ili korištenja ovog proizvoda. Strogo se pridržavajte uputa i sačuvajte ih za buduće potrebe.

PL: OSTRZEŻENIE PRZED WYWRÓCENIEM SIĘ MEBLA. Produkt musi być na stałe przymocowany do ściany dołączonymi uchwytemi, aby uniknąć śmiertelnego wypadku, gdy się wywróci. W pakiecie są tylko śruby pozwalające na przykręcenie uchwytów do produktu, które zapobiegają przewróceniu się produktu. Prosimy o skontaktowanie się ze specjalistycznym sklepem lub fachowcem w sprawie śrub lub kołków, które należy zastosować do danego typu ściany.
 GB: ANTI-TOPPLE WARNING! This product has to be permanently fixed to the wall with the bracket(s) included, to avoid fatal injury in case it topples over. The pack contains only screws for fastening the anti-topple bracket(s) itself to the product. Please contact your DIY or hardware store for advice on the correct type of screws/rawl plugs for your type of wall.
 FR: AVERTISSEMENT ANTIBASCULEMENT Ce produit doit être fixé de manière permanente au mur à l'aide du/des support(s) inclus afin d'éviter des blessures mortelles en cas de basculement. L'emballage contient des vis pour attacher le(s) support(s) antibasculement au produit. Veuillez contacter votre magasin de bricolage ou votre quincaillerie pour obtenir des conseils sur le type de vis/chevilles adapté à votre mur.
 CZ: VAROVÁNÍ TYKAJÍCÍ SE SKLOPENÍ! Tento výrobek musí být trvale připevněn na stěnu pomocí přiložených držáků, aby nedošlo ke smrtelnému zranění, kdyby se sklopil. Sada obsahuje pouze šroubky pro upevnění držáků zabraňujících sklopení k výrobku. Ohledně správného typu vrutů/hmoždinek pro daný typ stěny se obraťte na vhodný obchod nebo železářství.
 SK: VÝSTRAHA PRED PREVRÁTENÍM! Tento produkt musí byť natrvalo pripevnený k stene pomocou dodanej(-ých) konzoly (konzol), aby sa predišlo smrtelnému úrazu v prípade, že sa prevráti. Balenie obsahuje iba skrutky, ktorými sa pripevňujú k produktu samotné konzoly chrániace pred prevrátaním. Kontaktujte miestnu predajňu pre domácich majstrov alebo železiarstvo, kde vám poradia ohľadom správneho typu skrutiek/prichytiiek pre váš typ steny.
 DE: KIPPSICHERUNG Dieses Produkt muss ständig an der Wand mit der beigefügten Klammer befestigt werden. Um geeigneten Dübel und Schrauben zu verwenden fragen Sie bitte einen Fachmann nach.
 SRB: UPOZORENJE O ZAŠTITI OD PREVRTANJA! Proizvod mora biti trajno pričvršćen za zid pomoću isporučenih nosača kako bi se u slučaju prevrtanja proizvoda izbegle smrtonosne povrede. Sa proizvodom se isporučuju samo vijci za pričvršćivanje zaštitnih nosača na proizvod. Molimo Vas da od svog prodavca zatražite savet o vrsti vijaka/tipli koje su najprikladnije za Vaš zid.
 HR: UPOZORENJE O ZAŠTITI OD PREVRTANJA! Proizvod mora biti trajno učvršćen na zid s pomoću isporučenih nosača kako bi se u slučaju prevrtanja proizvoda izbegle smrtonosne ozljede. S proizvodom se isporučuju samo vijci za pričvršćivanje zaštitnih nosača na proizvod. Molimo Vas da od svog prodavača zatražite savjet o vrsti vijaka/tipli koje su najprikladnije za Vaš zid.

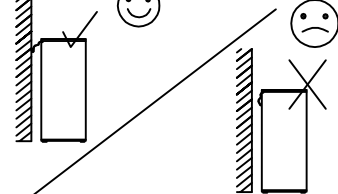
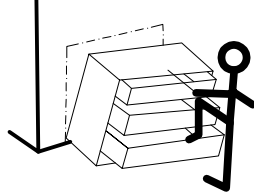
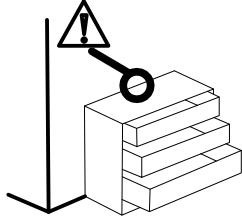

PL: OSTRZEŻENIE WS. USZKODZEŃ Aby uniknąć rys, ten mebel powinien być montowany, składany na miękkim podłożu, np. dywanie.
 GB: WARNING TO AVOID SCRATCHES! In order to avoid scratching this furniture should be assembled on a soft layer - could be a rug.
 FR: AVERTISSEMENT POUR ÉVITER LES RAYURES Afin d'éviter les rayures, ce meuble doit être monté sur une surface souple (un tapis, par exemple).
 CZ: VAROVANI TYKAJICI SE POSKRABANI! Aby nedošlo k poskrabaniu, sestavujte nabytok na mekkem podkladu - napr. na koberci.
 SK: VÝSTRAHA TYKAJUČA SA PREDCHADZANIA SKRABANCOM! Aby sa predišlo skrabancom, tento nabytok by mal montovať na nakkom podklade, napríklad na koberci.
 DE: WARNUNG GEGEN BESCHÄDIGUNGEN Um die Kratzer zu beseitigen, legen Sie bitte die Elemente auf einem weichen Boden, z.B. Teppich.
 SRB: UPOZORENJE O IZBEGAVANJU OGREBOTINA! Kako bi se izbegle ogrebotine ovaj proizvod je potrebno sastavljati na mekanoj površini-na primer, na tepihu.
 HR: UPOZORENJE O IZBJEGAVANJU OGREBOTINA! Kako bi se izbegle ogrebotine, ovaj proizvod potrebno je sastavljati na mekanoj površini-na primjerice, na tepihu.

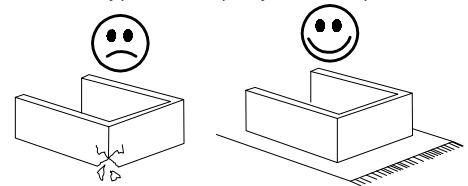

PL: OGÓLNE INSTRUKCJE DOTYCZĄCE MEBLI Z DREWNA ORAZ MATERIAŁÓW DREWNOPOCHODNYCH: MELAMINA, LAMINAT, OKLEINA Do czyszczenia należy używać wilgotnej ściereczki. Używać wyłącznie wody lub delikatnego detergentu. Wycierać do sucha ściereczką.
 GB: GENERAL INSTRUCTION FOR FURNITURE MADE OF WOOD OR WOOD COMPOSITES SUCH AS MELAMINE, LAMINATE OR VENEER SURFACES Wipe clean with a damp cloth. Use only water or a gentle detergent. Wipe dry with a clean cloth.
 FR: INSTRUCTIONS GÉNÉRALES POUR LE MOBILIER CONSTITUÉ DE BOIS OU DE COMPOSITES DE BOIS (COMME LES SURFACES EN MELAMINÉ, STRATIFIÉ OU PLACAGE) Nettoyer à l'aide d'un chiffon humide. Utiliser uniquement de l'eau ou un détergent doux. Essuyer à l'aide d'un chiffon propre.
 CZ: OBECNÉ POKYNY TYKAJÍCÍ SE NÁBYTKU VYROBENÉHO ZE DŘEVA NEBO Z KOMPOZITŮ DŘEVA, NAPŘ. S POVRCHEM Z MELAMINU, LAMINÁTU NEBO DÝHY! Čistíte otřením navlhčeným hadříkem. Používejte pouze vodu nebo jemný čistič prostředek. Vytřete dosucha čistým hadříkem.
 SK: VŠEOBECNÉ POKYNY PRE NÁBYTOK VYROBENÝ Z DŘEVA ALEBO KOMPOZITNÝCH MATERIÁLOV, NAPRIKLAD MELAMINU, LAMINÁTU ALEBO PREGLEJKOVÝCH POVRCHOV! Utrite dočista navlhčenou utierkou. Používajte iba vodu alebo jemný čistiaci prostriedok. Utrite dosucha čistou utierkou.
 DE: ALLGEMEINE ANWEISUNGEN FÜR REINIGUNG DES HOLZES UND HOLZÄHNLICHEN PRODUKTEN: MELAMIN, LAMINAT, BESCHICHTUNG Zur Möbelreinigung verwenden Sie ein mit Wasser oder Feinwaschmittel befeuchtetes, Baumwolltuch. Gereinigte Flächen immer trockenreiben!
 SRB: OPŠTE UPUTSTVO ZA NAMEŠTAJ IZRAĐEN OD DRVETA ILI DRVENIH KOMPOZITA, KAO ŠTO SU POVRŠINE OD MELAMINA, LAMINATA ILI FURNIRA! Očistiti vlažnom krpom. Upotrebljavati samo vodu ili blagi deterdžent. Posušiti čistom krpom.
 HR: OPĆE UPUTE ZA NAMJEŠTAJ IZRAĐEN OD DRVA ILI DRVNIH KOMPOZITA, KAO ŠTO SU POVRŠINE OD MELAMINA, LAMINATA ILI FURNIRA! Očistite vlažnom krpom. Upotrijebite samo vodu ili blagi deterdžent. Posušite čistom krpom.

PL: WAŻNE! Ważne jest, żeby każdy ze skręcanych produktów został ponownie dokręcony w ciągu 2 tygodni od montażu, a następnie sprawdzac co 3 miesiące czy śruby są dokręcone – w celu zapewnienia stabilności przez czas użytkowania produktu .

GB: IMPORTANT! It is important that any product which is assembled using any kind of screw is re-tightened 2 weeks after assembly, and once every 3 months - in order to assure stability through-out the lifespan of the product.

FR: IMPORTANT Il est important que tout produit monté à l'aide de vis soit resserré 2 semaines après son montage, puis tous les 3 mois, afin de garantir sa stabilité durant tout son cycle de vie.

CZ:DŮLEŽITÉ! U každého výrobku, který se sestavuje pomoci jakýchkoli šroubků, je důležité dotáhnout šroubky 2 týdny po sestavení a potom každé 3 měsíce, aby byla zajištěna stabilita po celou dobu životnosti výrobku.

SK:DŮLEŽITÉ! Je dôležité, aby sa na akomkoľvek produkte, montovanom pomocou akýchkoľvek skrutiek, skrutky dotiahli po dvoch týždňoch od montáže, a jedenkrát v priebehu každých 3 mesiacov - tak sa zaručí stabilita počas celej životnosti produktu.

DE: WICHTIG! Es ist sehr wichtig ca. 2 Wochen nach der Montage alle Befestigungen zu überprüfen und dieses Vorgehen jede 3 Monate zu wiederholen, um Lebensdauer des Möbels zu verlängern.

SRB: VAŽNO! Važno je da se svi tipovi vijaka na bilo kojoj vrsti proizvoda koji se pomoću njih sastavlja ponovo pritegnu 2 nedelje nakon sastavljanja kao i jednom svaka 3 meseca-kako bi se osigurala stabilnost tokom životnog veka proizvoda.

HR: VAŽNO! Važno je da se svi tipovi vijaka na bilo kojoj vrsti proizvoda koji se s pomoću njih sastavlja ponovo pritegnu 2 tjedna nakon sastavljanja te jednom svaka 3 mjeseca-kako bi se zajamčila stabilnost tijekom životnog vijeka proizvoda.

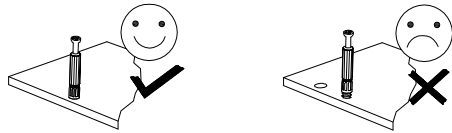

PL: OSTRZEŻENIE DOTYCZĄCE SZKŁA HARTOWANEGO!

- Nie należy uderzać w szkło twardymi lub ostrym przedmiotami
- Nie używać powierzchni szklanej do krojenia
- Nienależy stawiać ani siadać na powierzchni szklanej.
- Nie należy umieszczać bardzo gorących ani bardzo zimnych przedmiotów bezpośrednio na powierzchni szklanej
- Do czyszczenia szkła używać wilgotnej ściereczki oraz płynu do mycia lub miękkiego mydła.
- Nie wolno stosować żadnych środków o właściwościach ściernych, które mogłyby zarysować szkło

GB: WARNING REGARDING TEMPERED GLAS!

- Do not strike glass with hard or pointed items
- Do not use the glass as a chopping surface
- Do not sit or stand upon glass surface(s)
- Do not place very hot – or very cold items in direct contact with the glass surfaces(s)
- Only clean glass using a damp cloth with washing up liquid or soft soap, do not use any substances containing abrasives since they scratch the glass

FR: AVERTISSEMENT CONCERNANT LE VERRE TREMPÉ

- Ne pas frapper le verre avec des objets durs ou contondants
- Ne pas utiliser le verre comme surface pour couper
- Ne pas s'asseoir ou se mettre debout sur la surface en verre
- Ne pas poser d'objets très chauds ou très froids sur la surface en verre
- Pour le nettoyage du verre, utiliser exclusivement un morceau de tissu humide avec un liquide nettoyant ou du savon doux ; ne pas utiliser de substance contenant des abrasifs, risquant de rayer le verre

CZ: UPOZORNĚNÍ TÝKAJÍCÍ SE TVRZENÉHO SKLA!

- Nebouchejte do skla tvrdými nebo špičatými předměty
- Nepoužívejte sklo jako kuchyňské prkénko
- Na skleněné povrchy nesedejte a nestoupejte
- Nepokládejte přímo na skleněné povrchy velmi horké nebo velmi chladné předměty
- K čištění skla používejte pouze vlhký hadřík s tekutým prostředkem na nádobí nebo měkkým mýdlem. Nepoužívejte látky obsahující brusné materiály, protože by mohlo dojít k poškrábání skla

SK: VAROVANIE OHLADOM TVRDENÉHO SKLA!

- Neudierajte do skla tvrdými ani zahrotenými predmetmi
- Nepoužívajte sklo ako podložku na sekanie
- Nesadajte si ani sa nestavajte na sklenený povrch
- Priamo na sklenený povrch neukladajte veľmi horúce alebo veľmi chladné predmety
- Pri čistení skla používajte len vlhkú handričku s tekutým čistiacim prostriedkom na riad alebo mäkkým mydlom.
- Nepoužívajte látky obsahujúce brúsiace materiály, pretože by mohli poškríabať sklo

DE: Gehen Sie vorsichtig mit Hartglas um!

- Ein beschädigter Rand oder eine verkratzte Oberfläche können zum Bruch des Glaselements führen.
- Mann darf nicht stehen oder sitzen auf der Glassoberfläche.
- Mann darf keine heisse oder sehr kalte Gegenstände direkt auf die Glassoberfläche stellen.
- Vermeiden Sie Schläge von der Seite, weil Glas gegen seitliche Beschädigungen am empfindlichsten ist.
- Waschen Sie die Glassoberfläche mit einem weichen Tuch und mit Feinwaschmittel oder Seife.
- Mann darf keine Mittel verwenden die Kratzen verursachen.

SRB: UPOZORENJE U VEZI SA OJAČANIM STAKLOM!







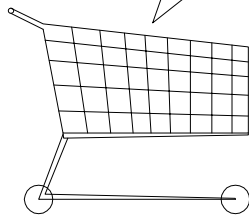
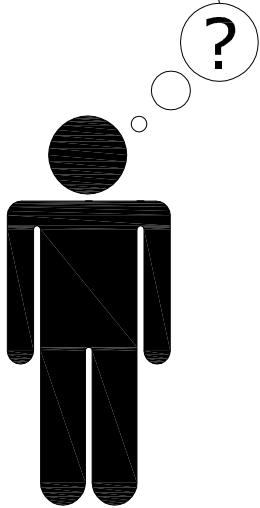
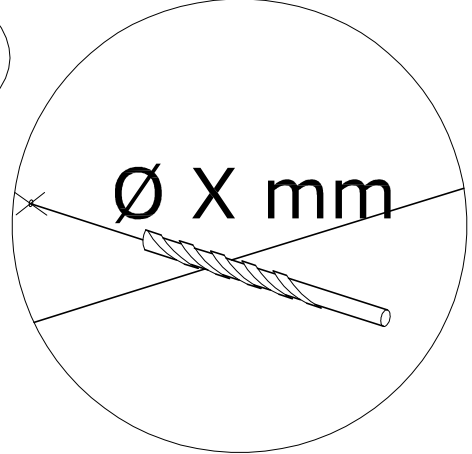
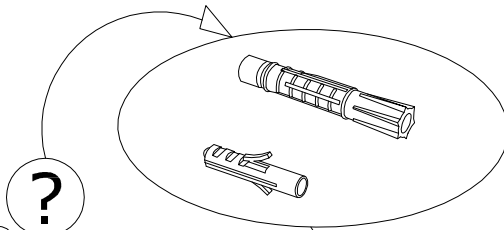
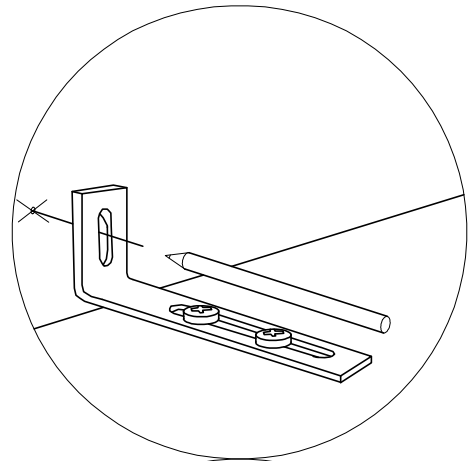
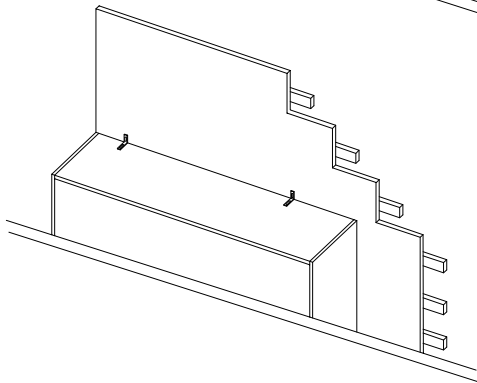
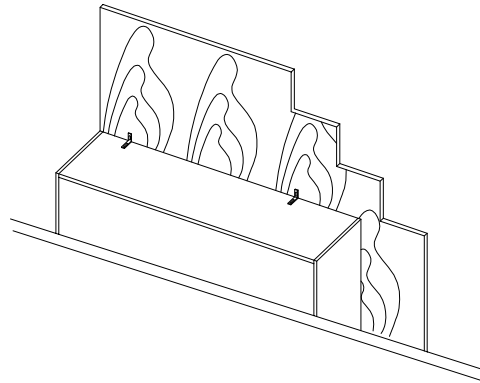
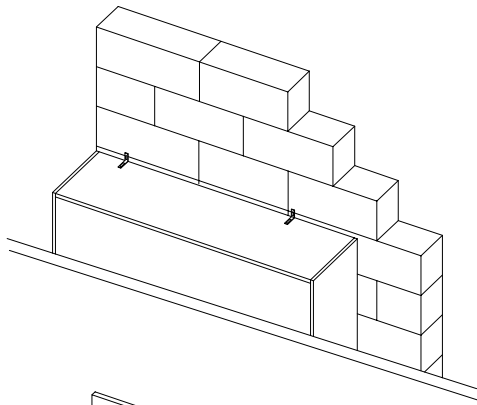

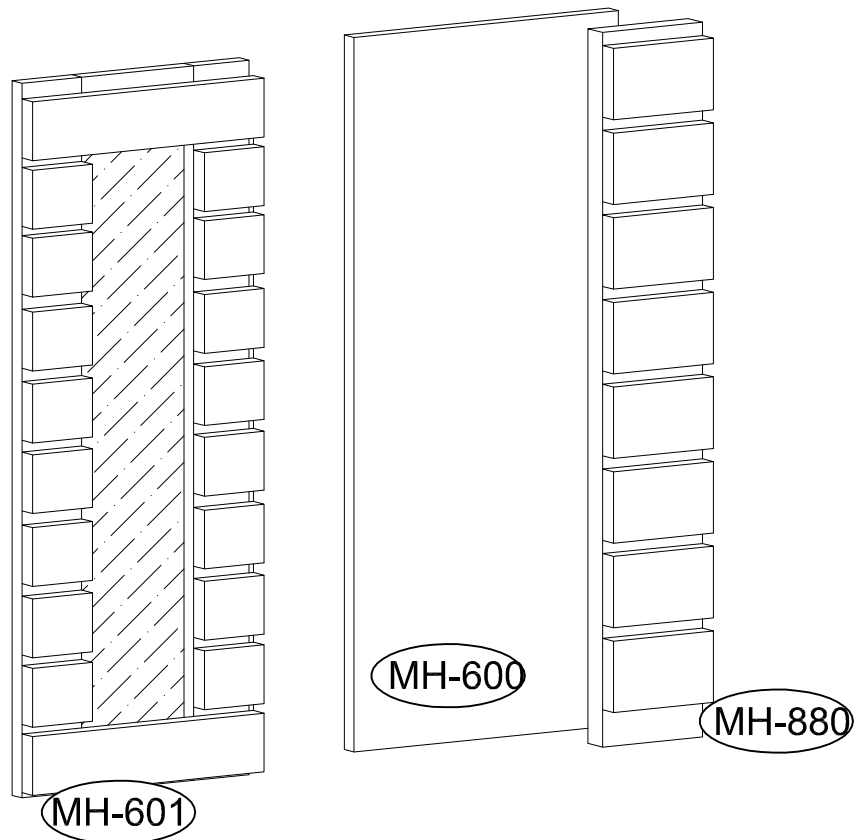
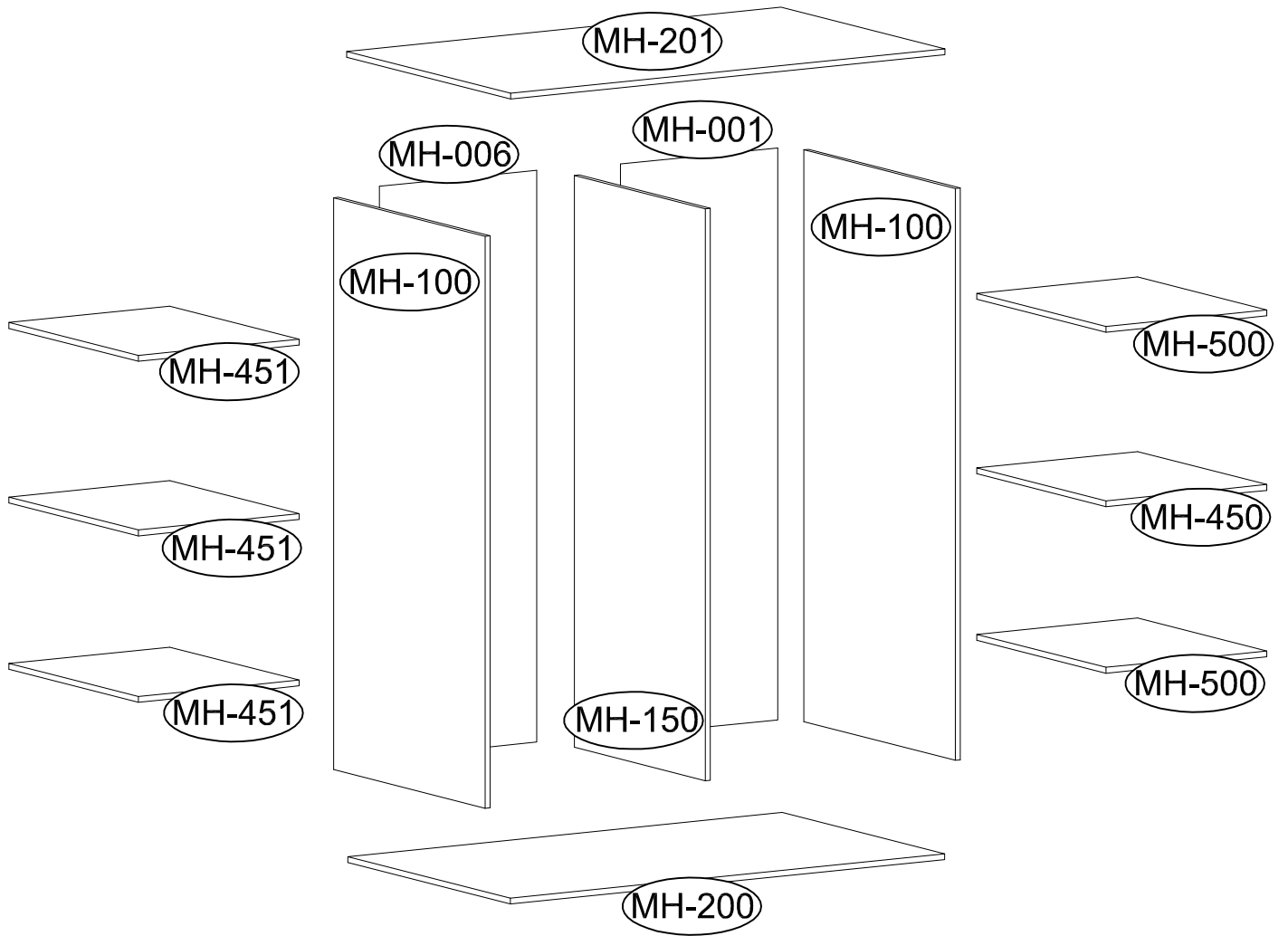

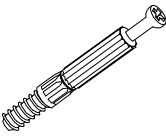
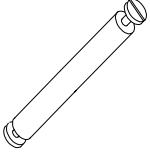
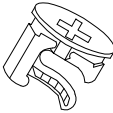
- Ne udarajte po staklu teškim i oštrim predmetima
- Ne koristite staklo kao podlogu za seckanje
- Nemojte sedeti ili stajati na staklenoj površini, odnosno površinama
- Ne stavljajte veoma vruće kao ni veoma hladne predmete direktno na staklenu površinu, odnosno površine
- Za čišćenje stakla koristite samo krpu navlaženu sredstvom za čišćenje ili blagim sapunom-ne koristite sredstva koja sadrže abrazive jer ona grebanjem oštećuju staklo

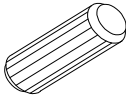
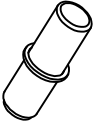
HR: UPOZORENJE U VEZI S OJAČANIM STAKLOM!

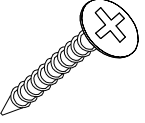
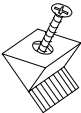
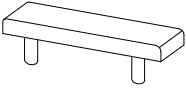
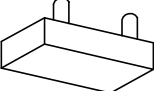
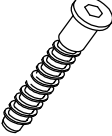
- Ne udarajte po staklu teškim i oštrim predmetima
- Ne koristite staklo kao podlogu za sjeckanje
- Nemojte sjediti ili stajati na staklenoj površini, odnosno površinama
- Ne stavljajte veoma vruće ni veoma hladne predmete u izravni dodir sa staklenom površinom, odnosno površinama
- Za čišćenje stakla koristite samo krpu navlaženu tekućinom za čišćenje ili blagim sapunom – ne koristite tvari koje sadrže abrazive, jer one grebanjem oštećuju staklo

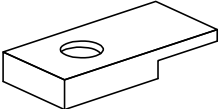

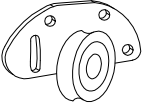
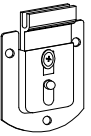
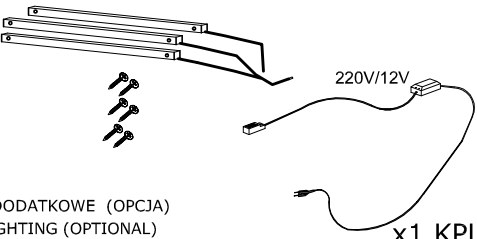
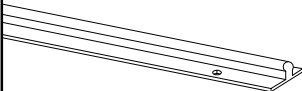

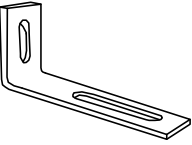
<p>4066</p>  <p>Ø6.5x36.5mm x24</p>	<p>4060</p>  <p>x2</p>	<p>3996</p>  <p>Ø15x16mm x28</p>	<p>136236</p>  <p>Ø20 x28</p>
<p>3989</p>  <p>Ø8x30mm x20</p>	<p>4017</p>  <p>x8</p>	<p>3879</p>  <p>Ø6.3x13mm x4</p>	<p>3923</p>  <p>Ø4,0x16mm x32</p>
<p>4044</p>  <p>x24</p>	<p>4057</p>  <p>x6</p>	<p>IN01112</p>  <p>H-20 mm x1</p>	<p>3884</p>  <p>x6</p>
<p>IN01032</p>  <p>H-18 mm x6</p>	<p>3984</p>  <p>4 mm x1</p>	<p>4076</p>  <p>x10</p>	<p>3919</p>  <p>Ø3,0x20mm x10</p>
<p>IN01007</p>  <p>x4</p>	<p>IN01006</p>  <p>x4</p>	<p>IN02435</p>  <p>220V/12V x1 KPL</p> <p>OŚWIETLENIE DODATKOWE (OPCJA) ADDITIONAL LIGHTING (OPTIONAL)</p>	
<p>83655</p>  <p>L-1166mm x4</p>	<p>3912</p>  <p>Ø3,0x13mm x16</p>	<p>71900</p>  <p>x2</p>	

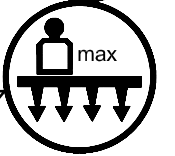
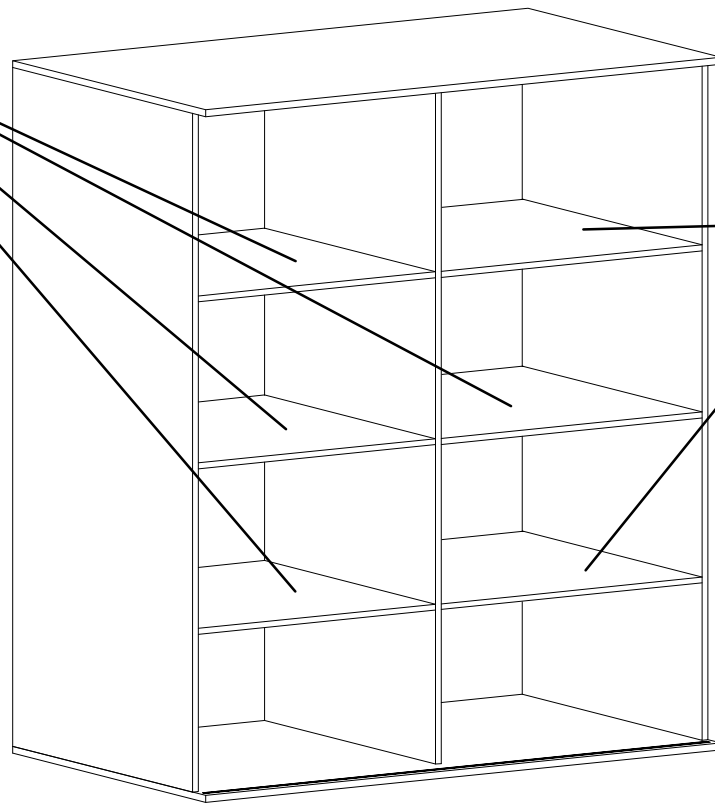
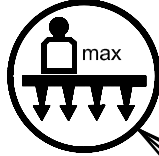
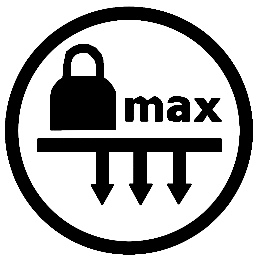

1

4057

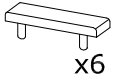

x6

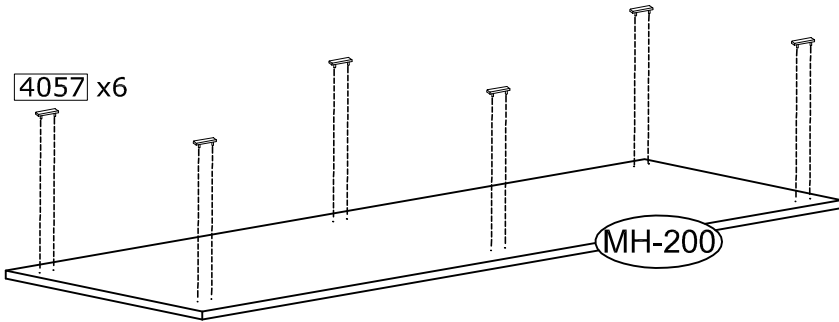
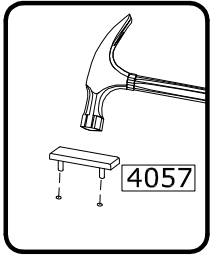

2

4066



x6

83655

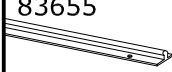

x2

3912



3,0X13 x8

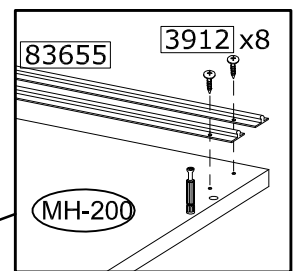
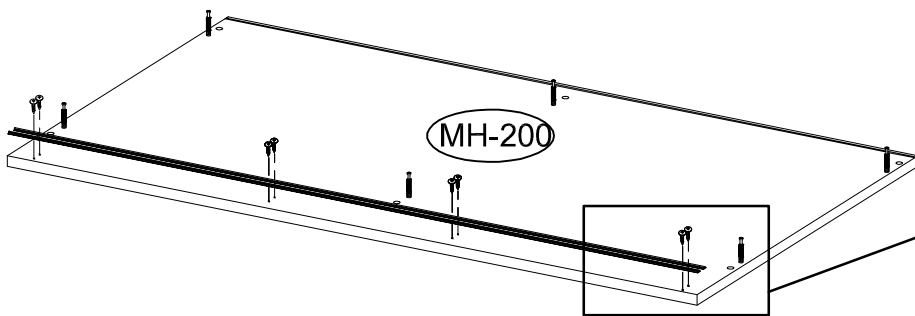
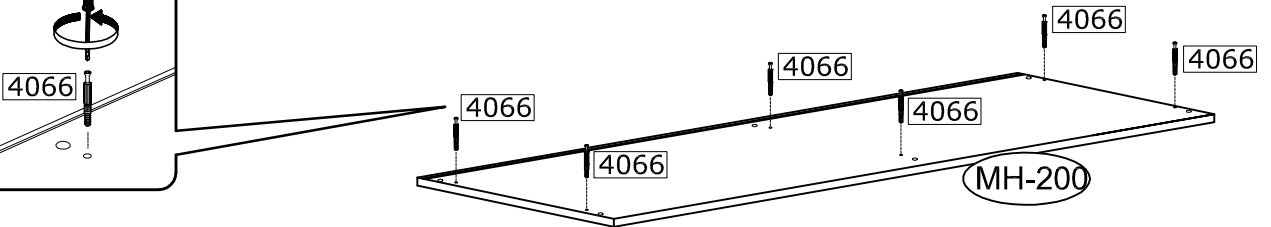
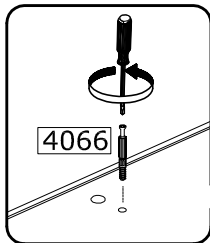

3

4066



x6

3989



x4

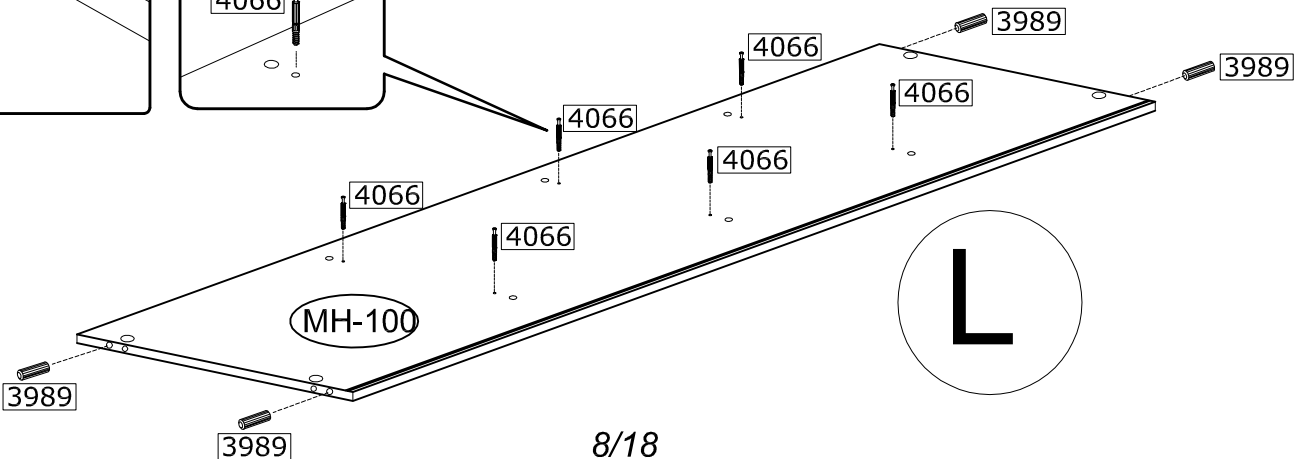
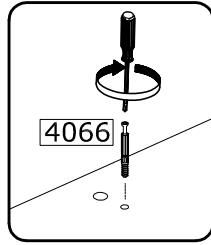
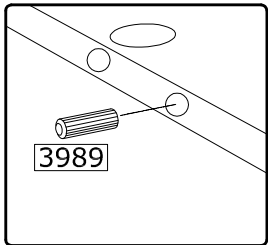

4

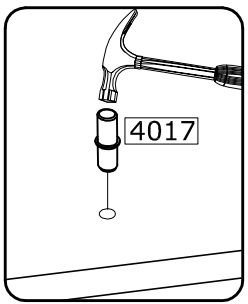
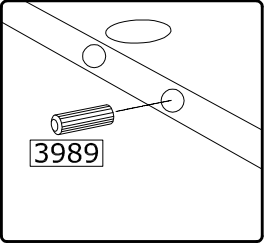
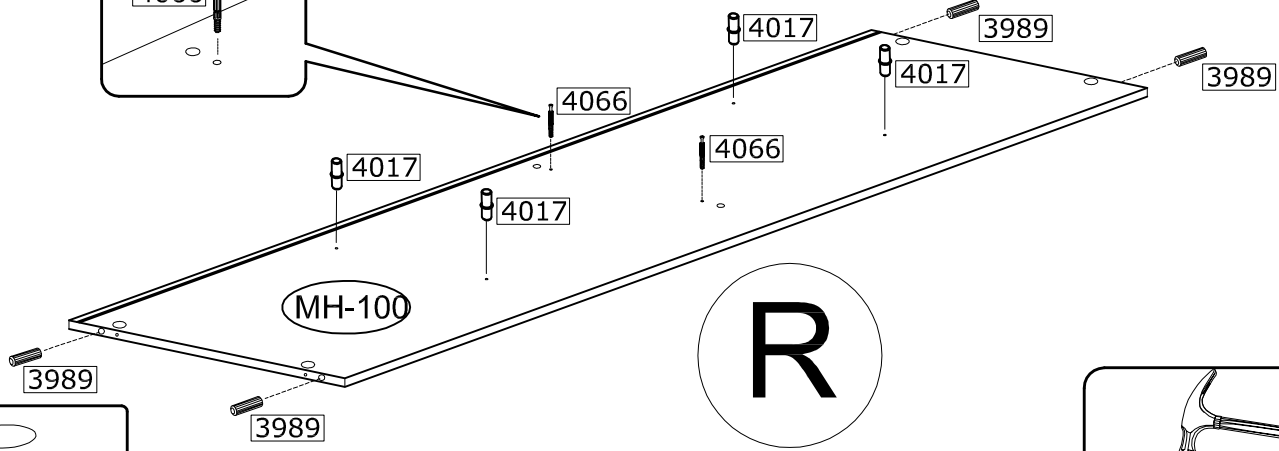
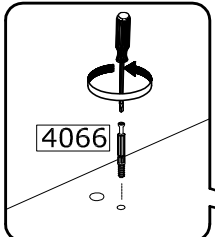
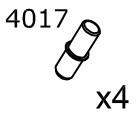
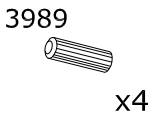

5

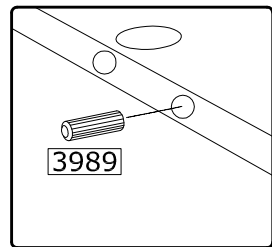
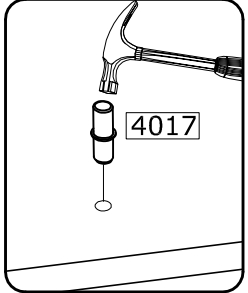
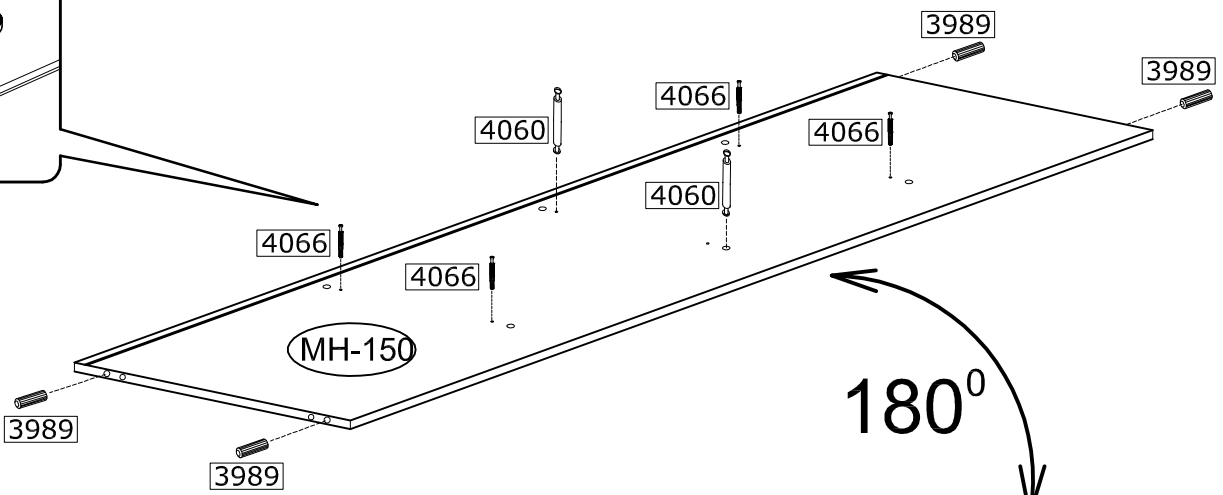
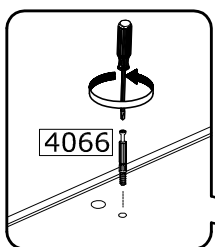
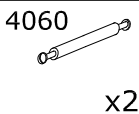
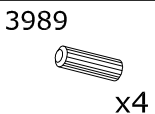

6

3989
x12

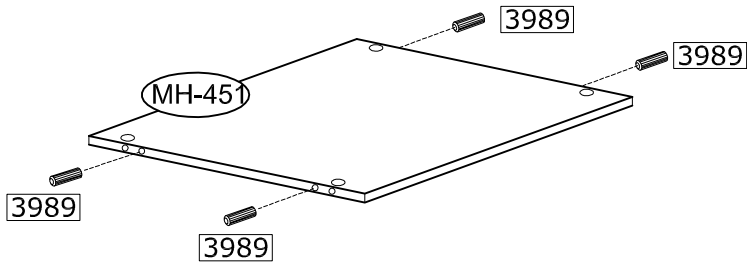
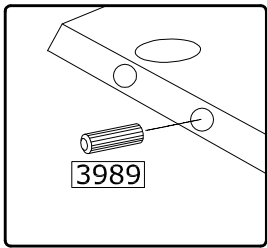
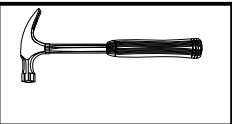

X3

7

3989
x4

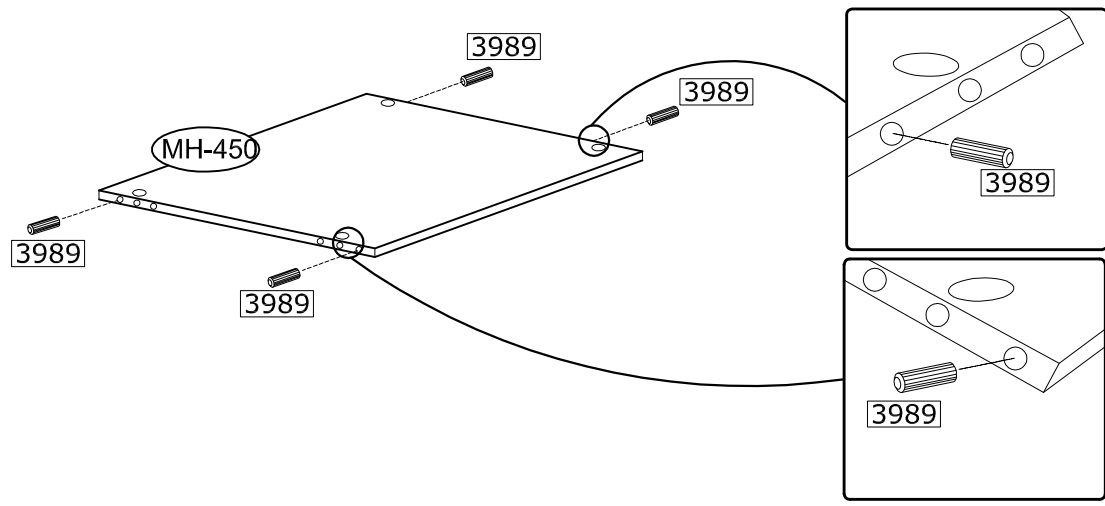
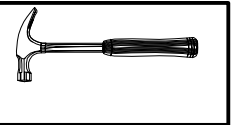

8

IN02435
x1 KPL

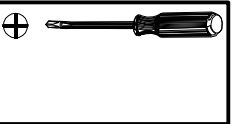

X3

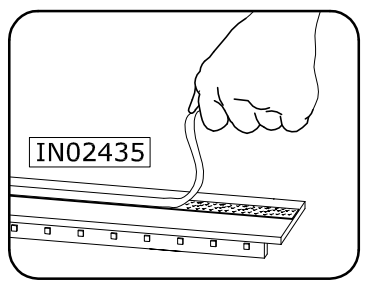
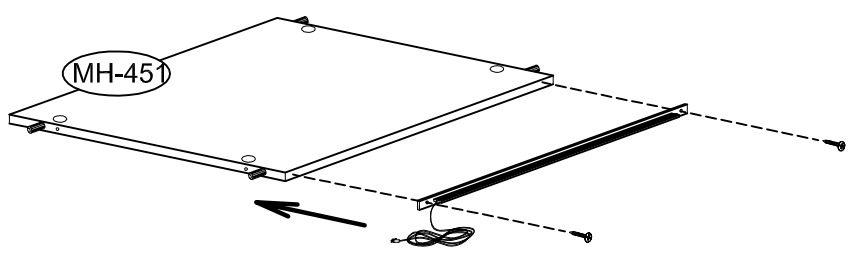

OŚWIETLENIE DODATKOWE (OPCJA)
ADDITIONAL LIGHTING (OPTIONAL)

9

3996



x12

136236

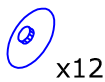

x12

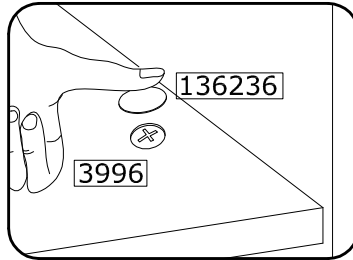
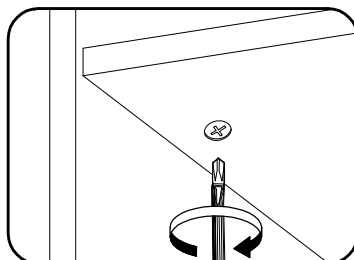
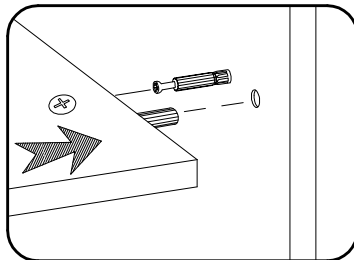
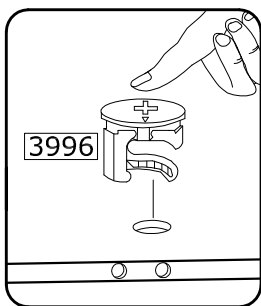
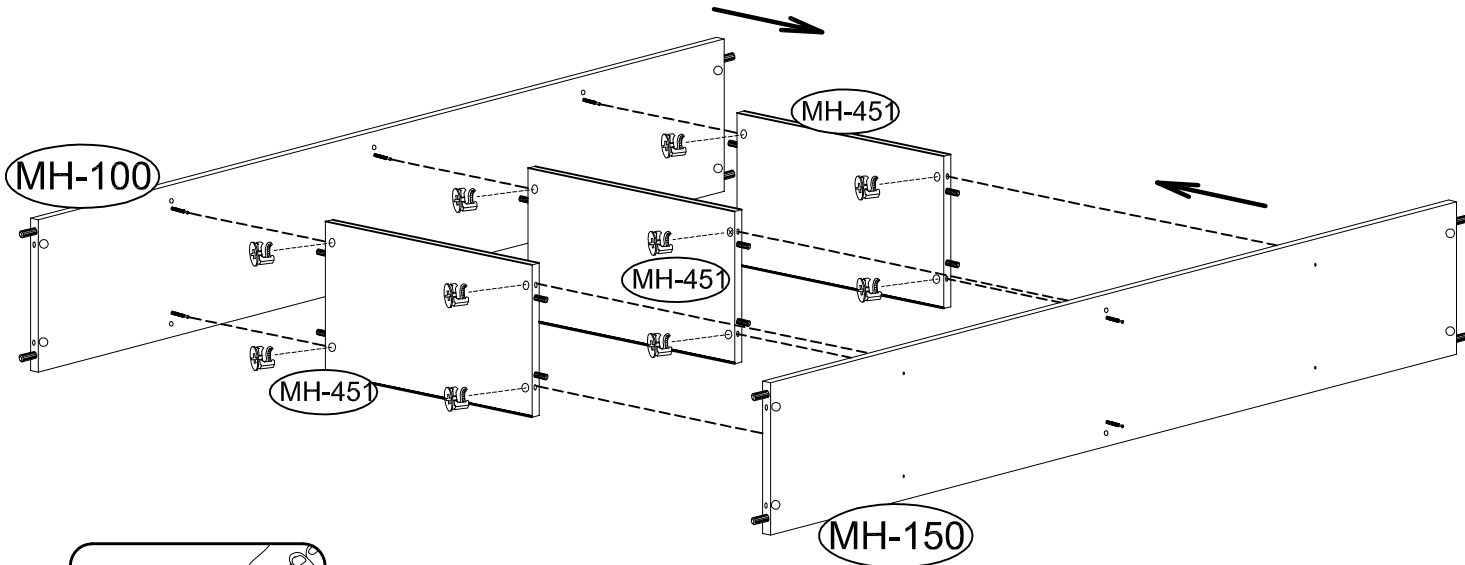

10

3996



x4

136236



x4

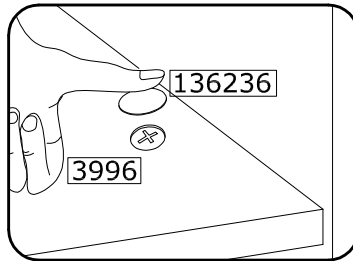
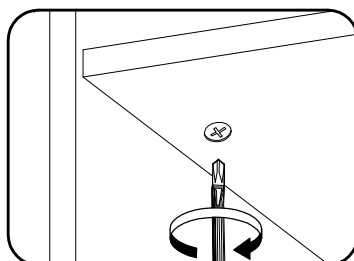
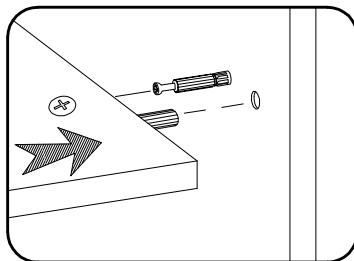
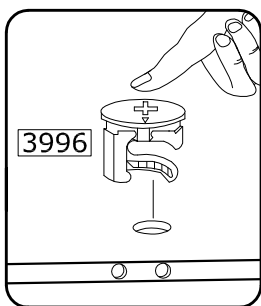
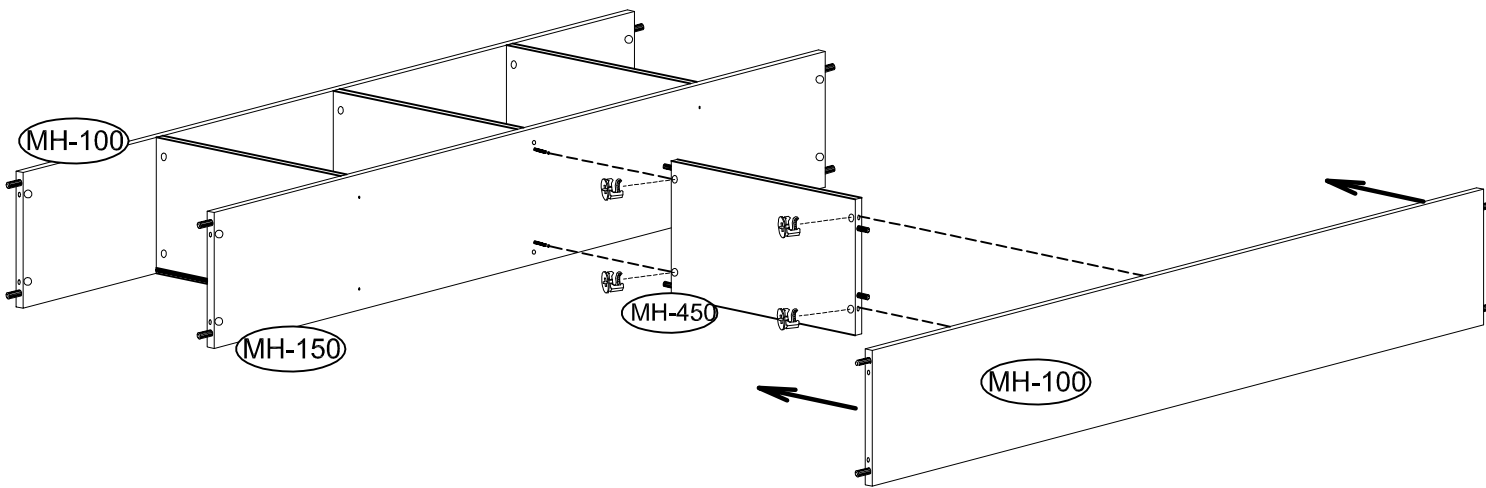

11

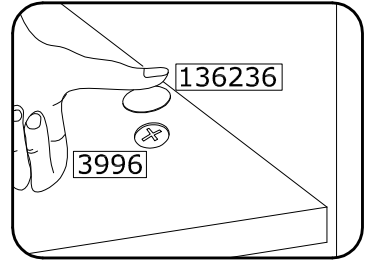
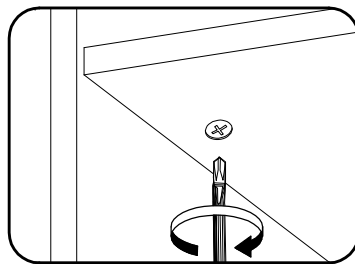
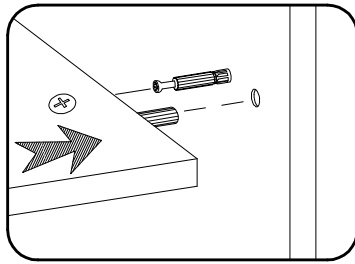
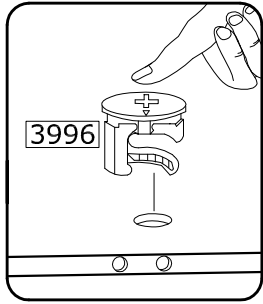
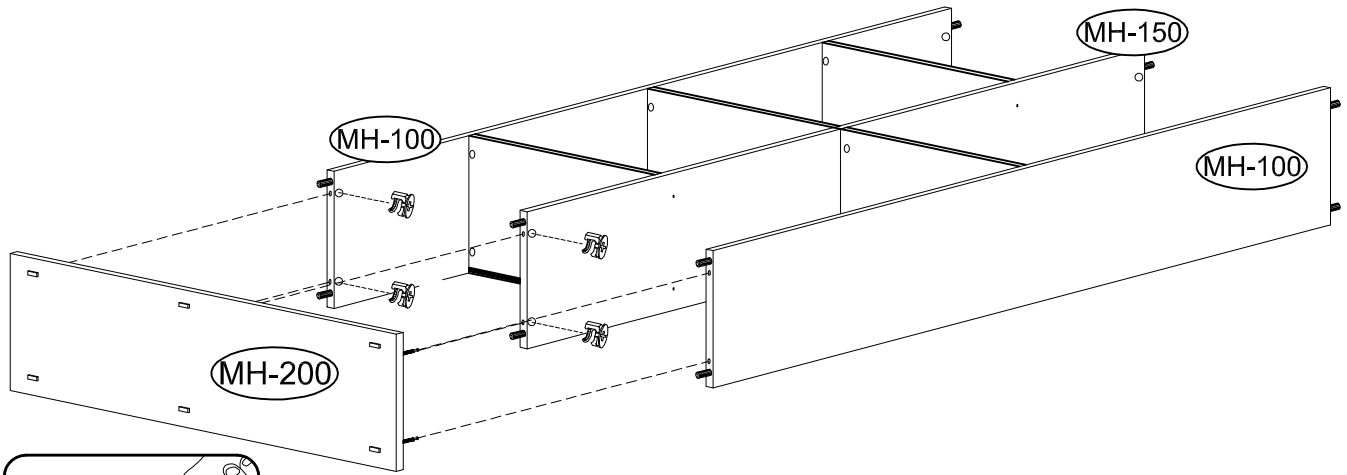
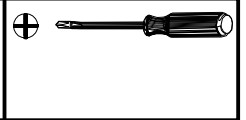
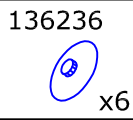
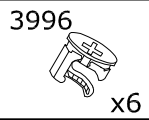

12

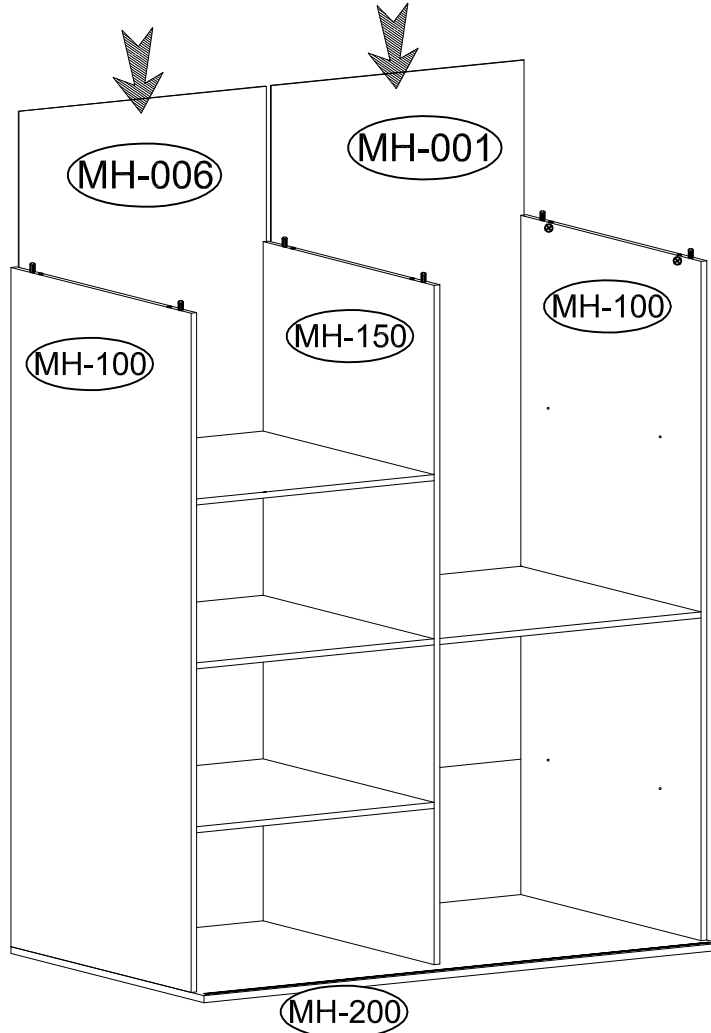

13

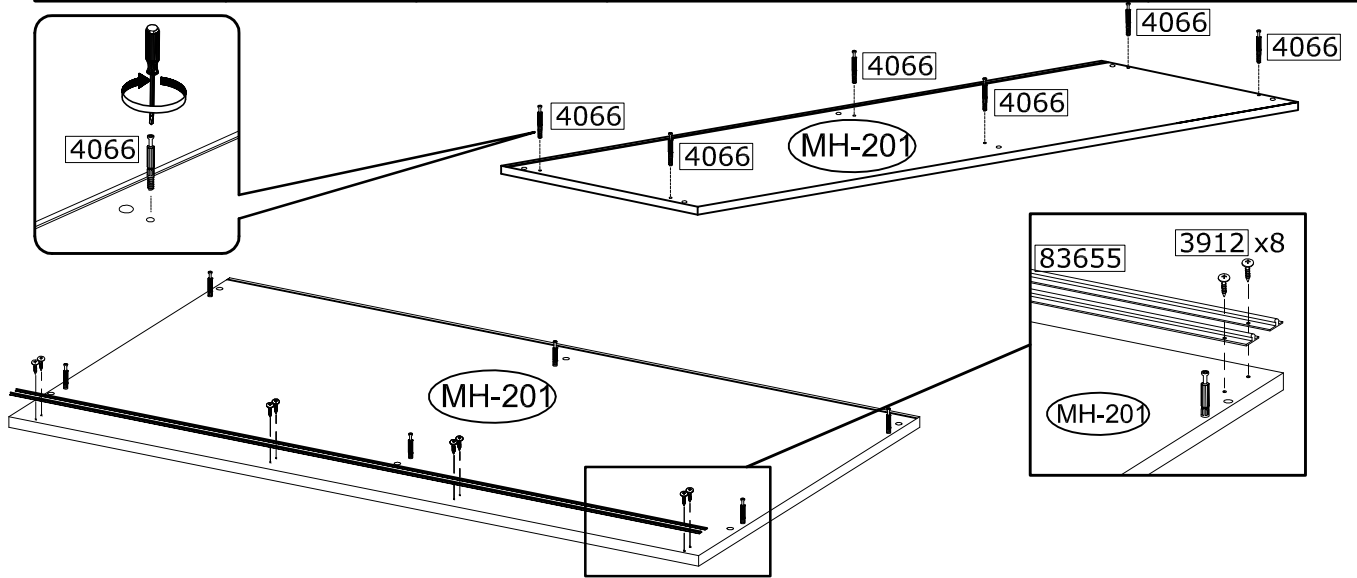
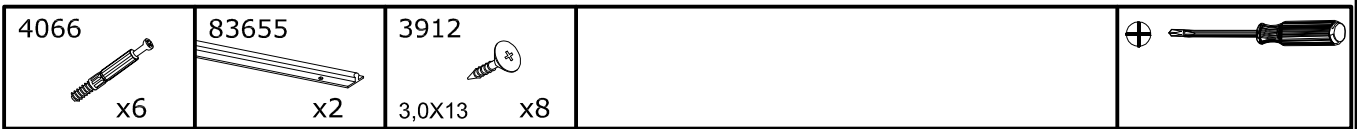

14

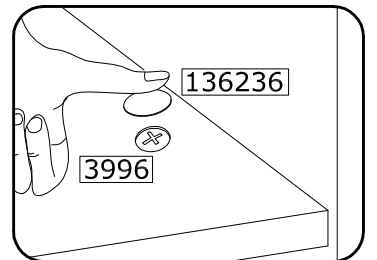
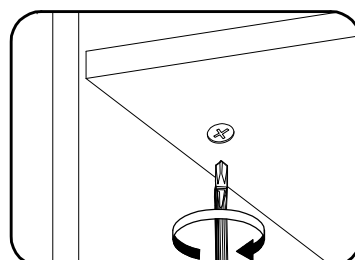
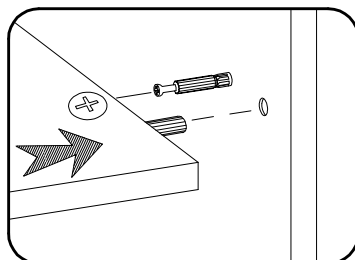
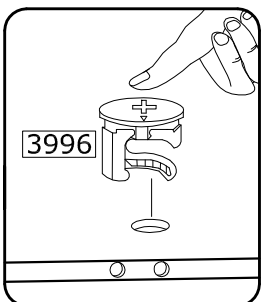
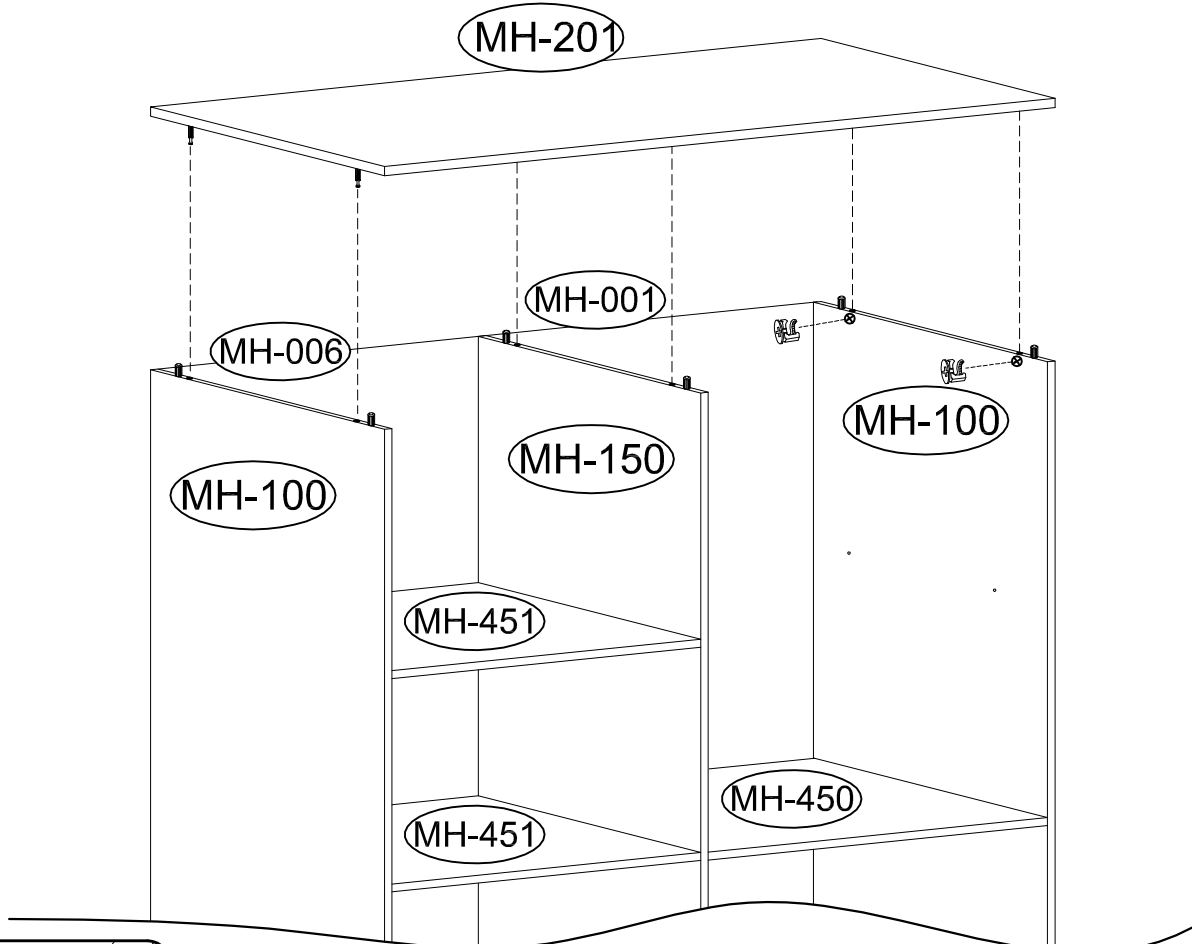

15

4044



x24

IN02435



x1 KPL

+

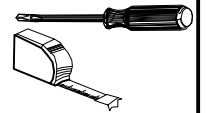

XX = YY

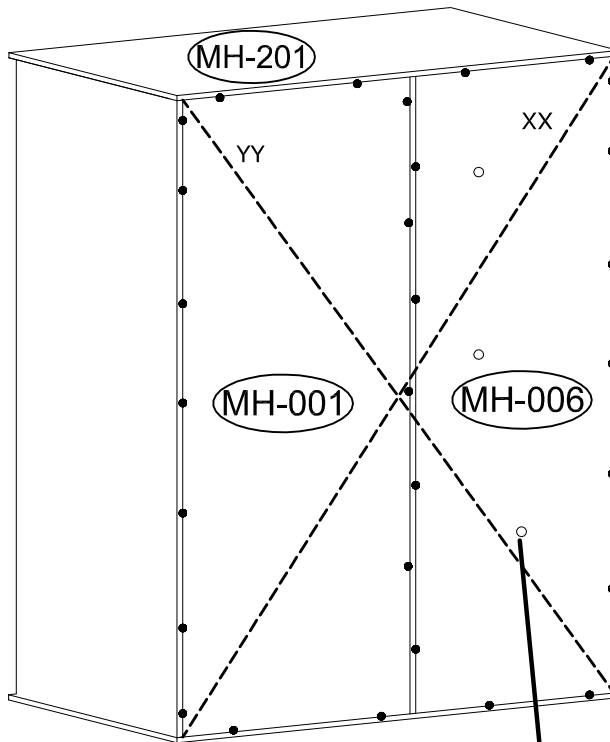

OŚWIETLENIE DODATKOWE (OPCJA)
ADDITIONAL LIGHTING (OPTIONAL)

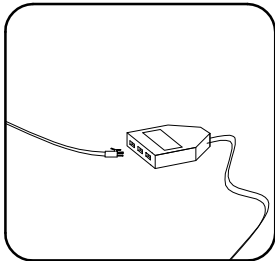
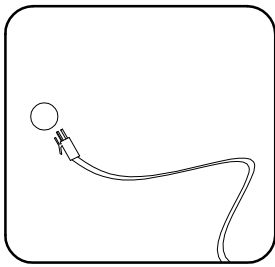

IN02435

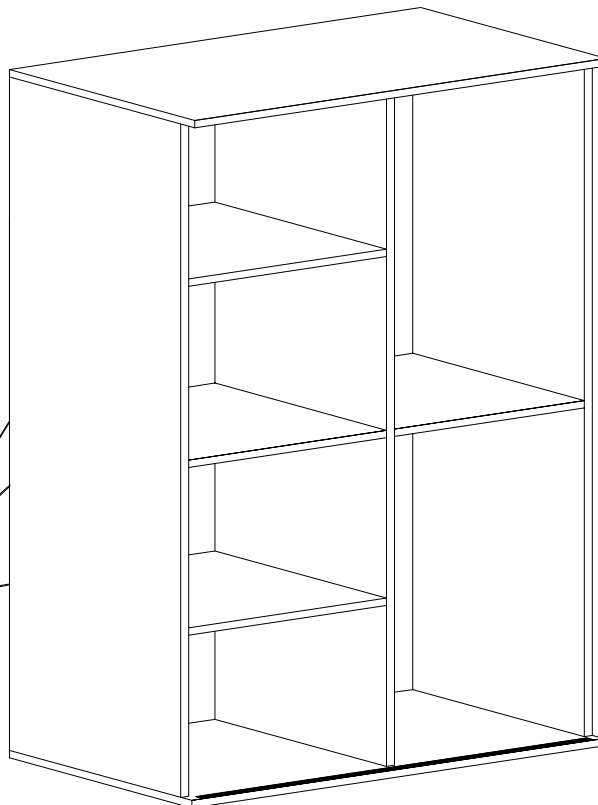
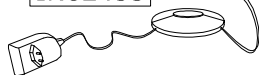



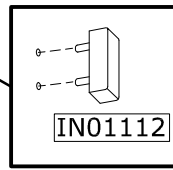
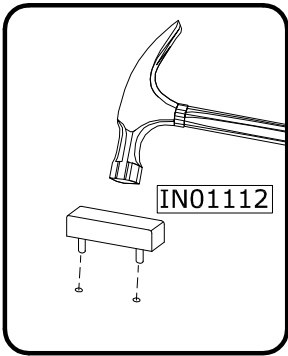
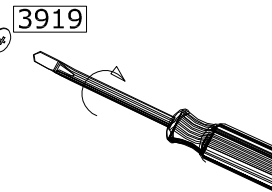
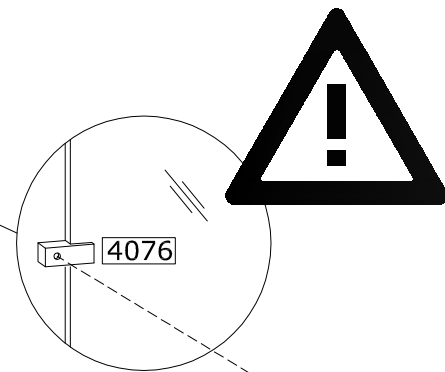
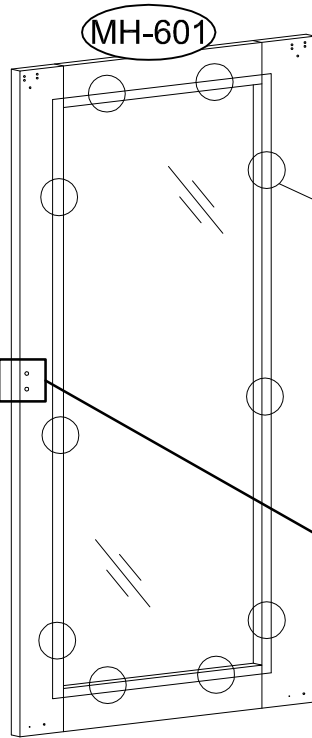
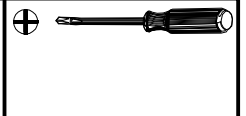
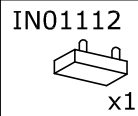
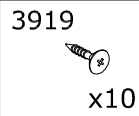
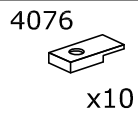

16

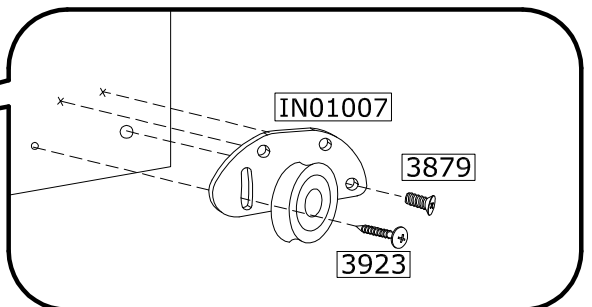
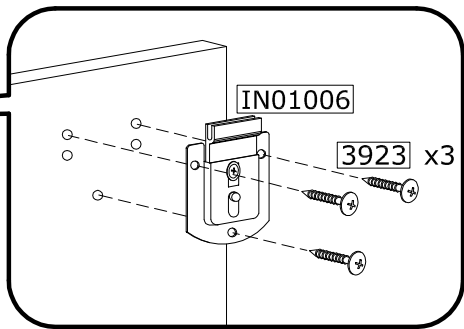
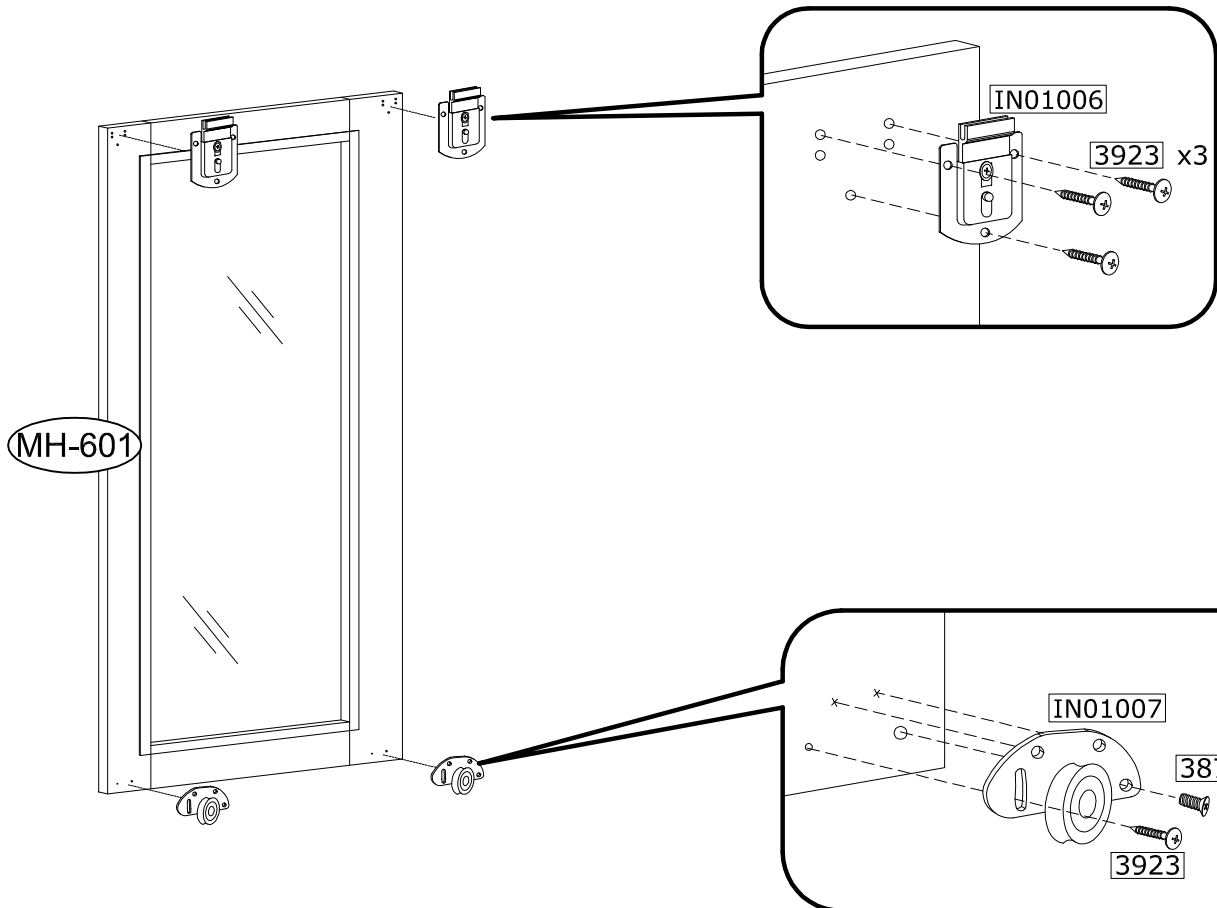
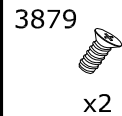
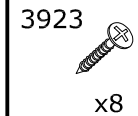
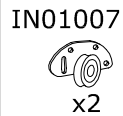

17



18

IN01006  x2	IN01007  x2	3923  x8	3879  x2		
---	---	--	--	--	---

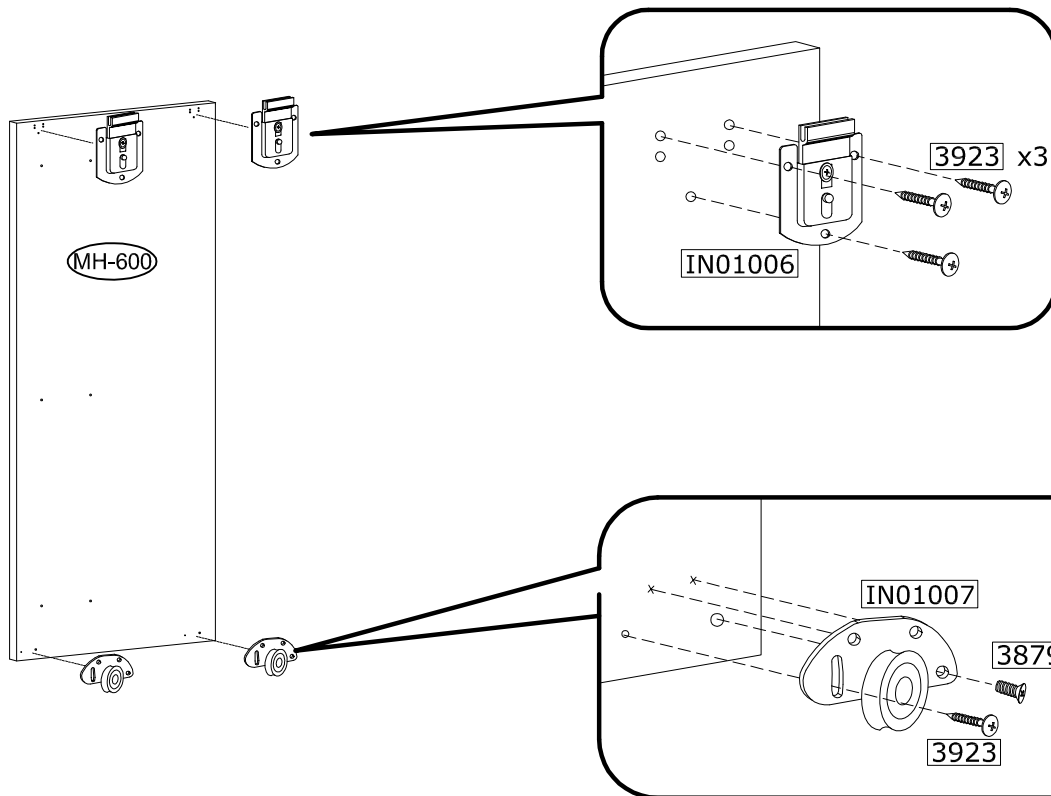

19

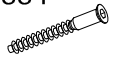
IN01032  x6	3884  x6		
--	---	--	--

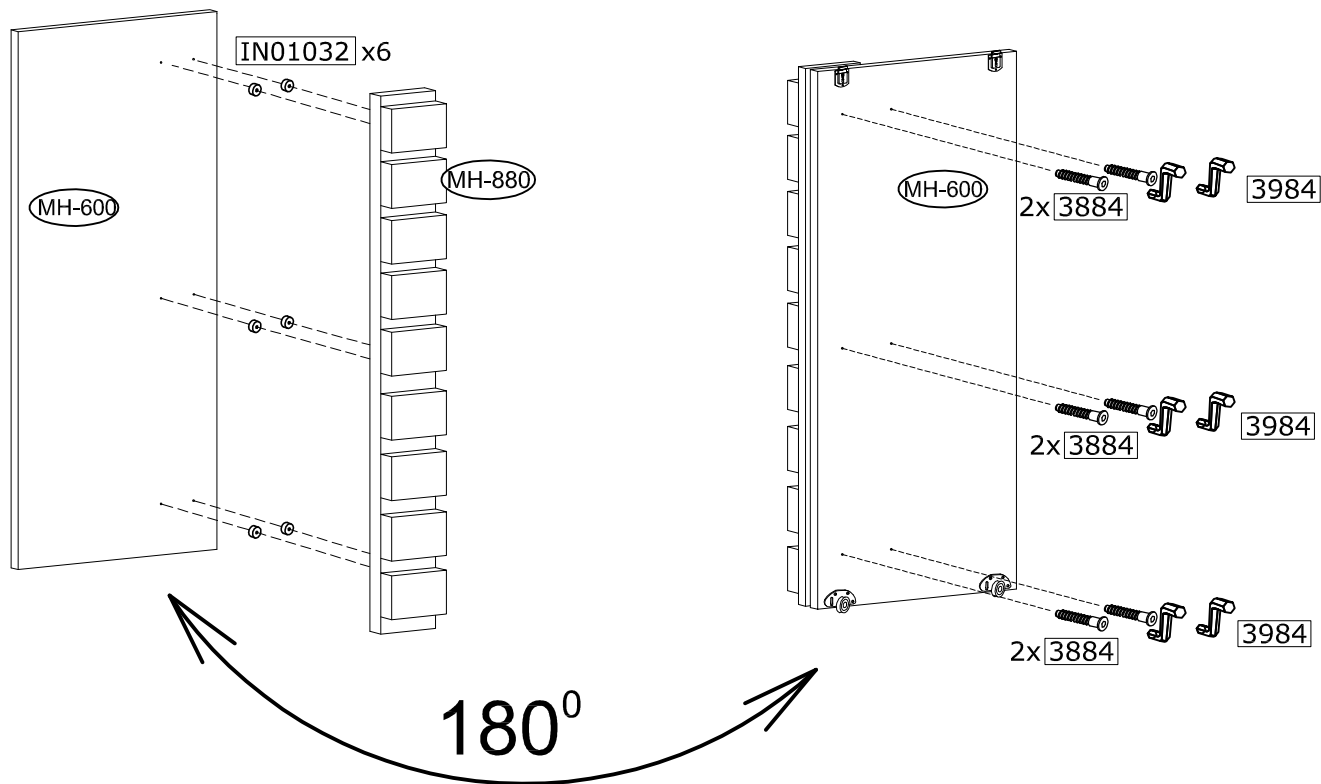

20

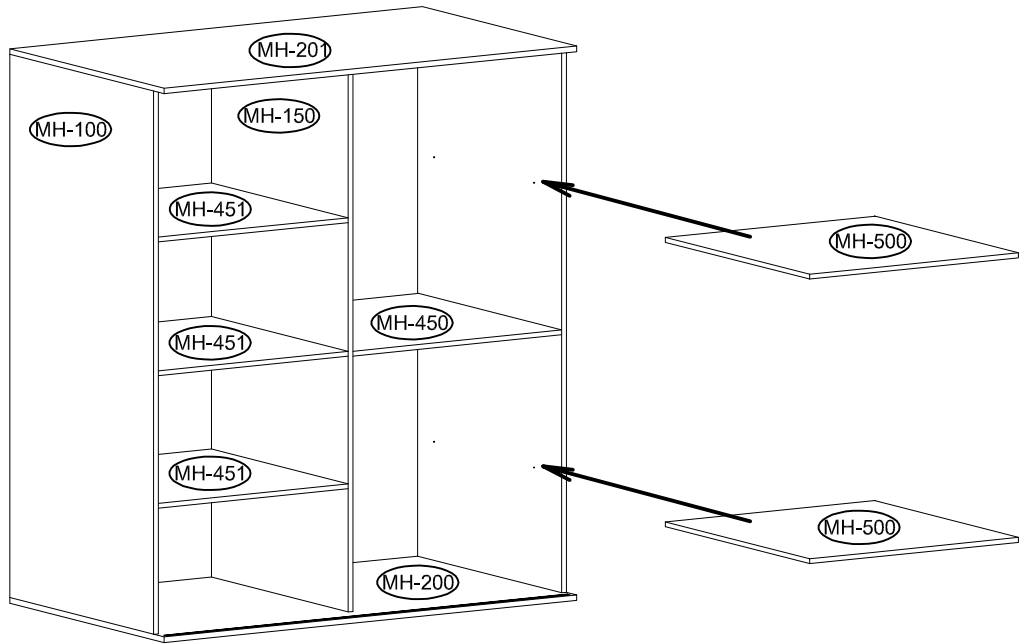

21

3923

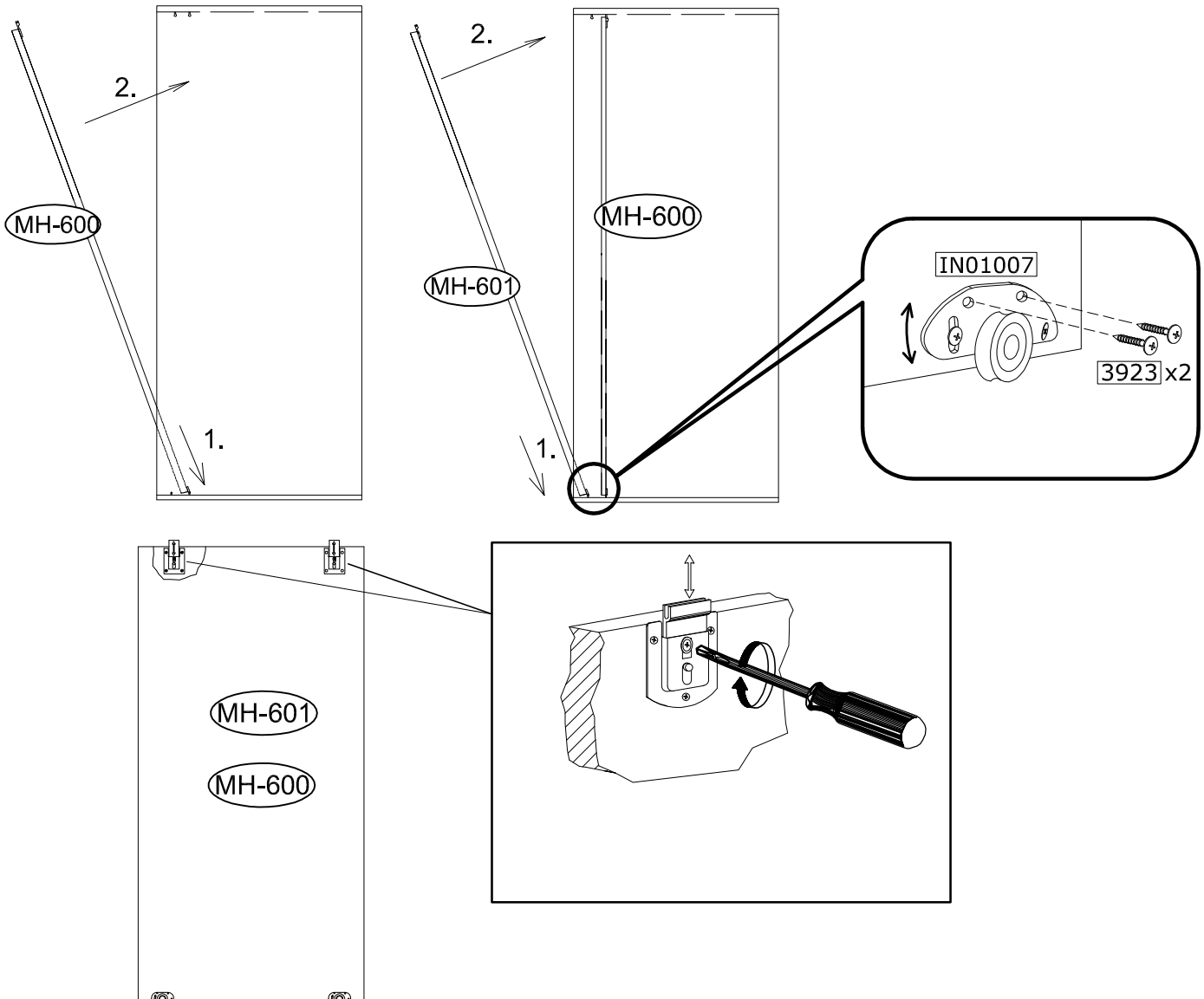

22

71900



3923

