

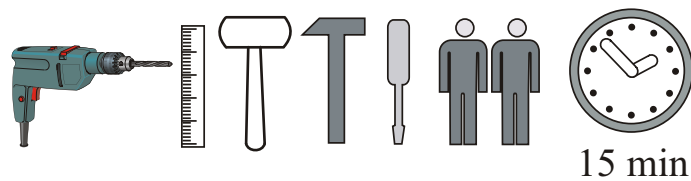

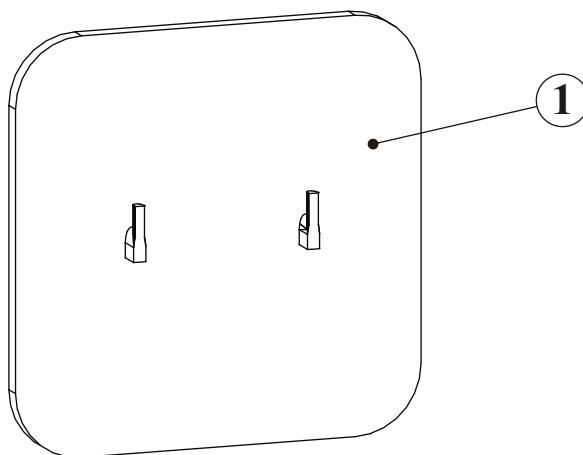

WALLY TYP 10

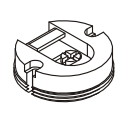

NO	Dim.			Col.-No	Qty
1	350	350	16	1	1

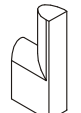
WALLY TYP 10

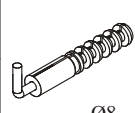
ZM1 x3		D20 x6	 ESØ6x9,5	WS1 x2		UP6 x4	 UPØ4x30	KR2 x3	 Ø8
-----------	-----------------------------------------------------------------------------------	-----------	-----------------------------------------------------------------------------------------------	-----------	-----------------------------------------------------------------------------------	-----------	-----------------------------------------------------------------------------------------------	-----------	-------------------------------------------------------------------------------------------

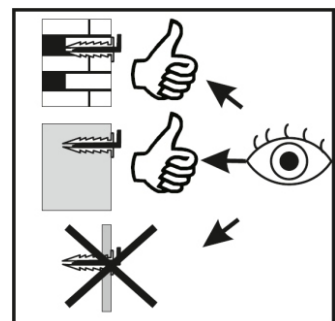
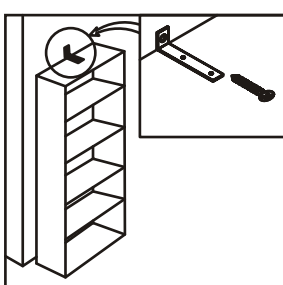
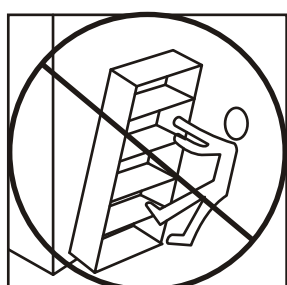
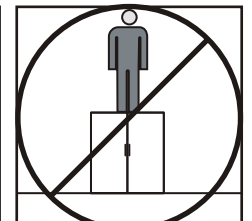
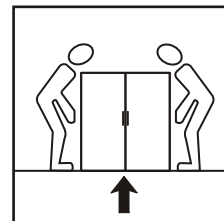
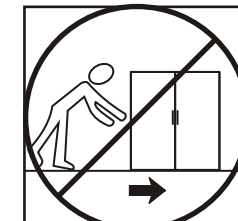
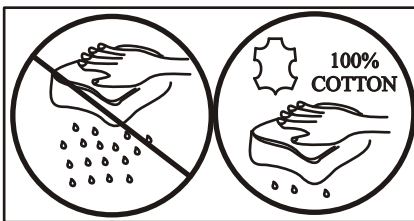
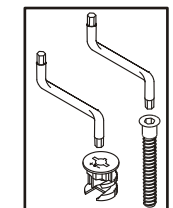
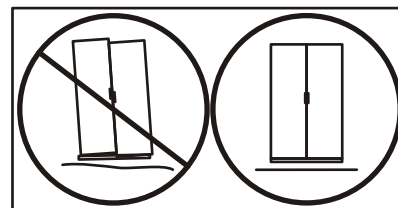
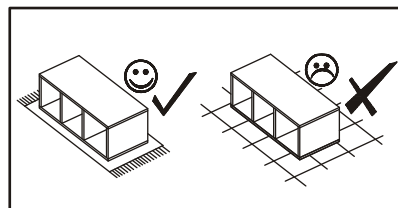
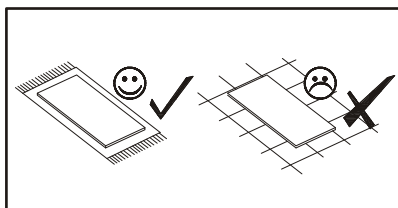
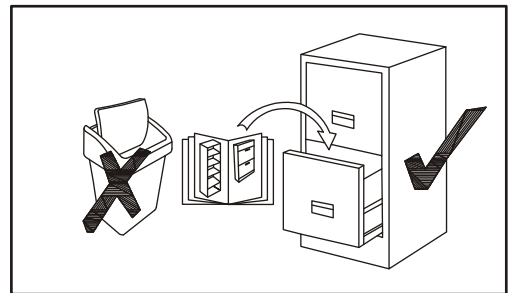
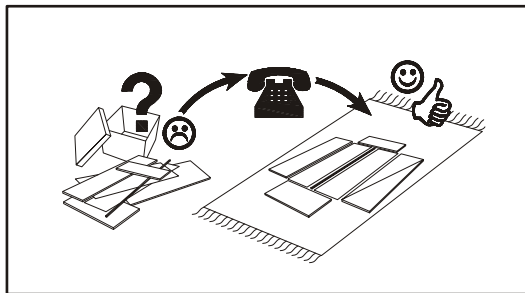
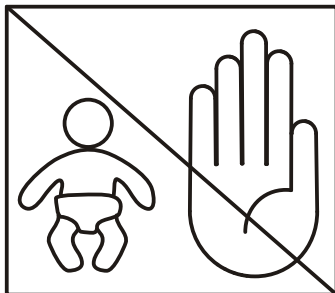
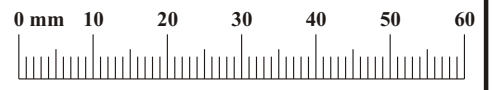

WALLY TYP 10

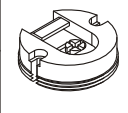
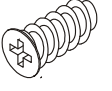
ZM1		D20	
x3		x6	ESØ6x9,5

1

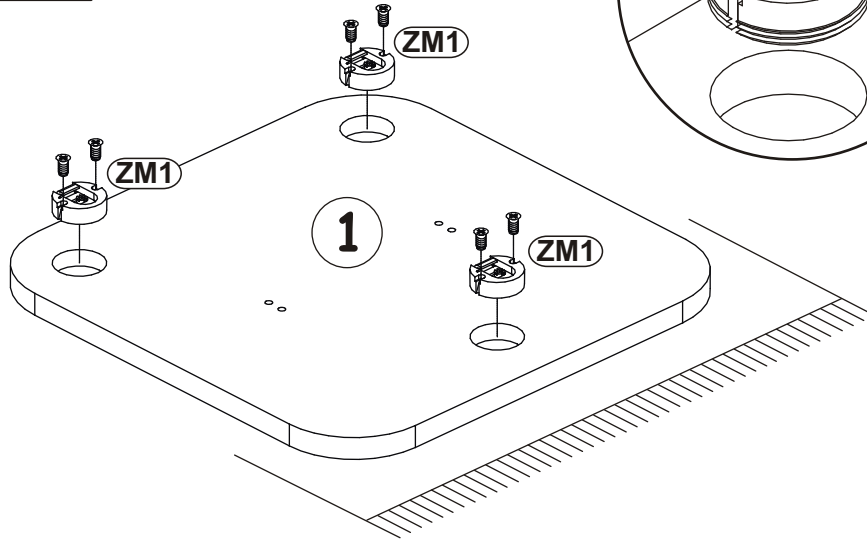
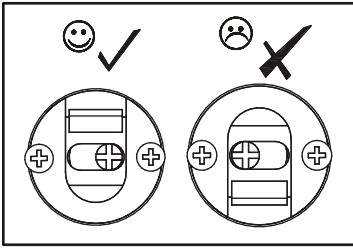

2

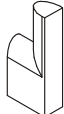
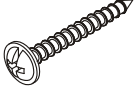
WS1		UP6	
x2		x4	UPØ4x30

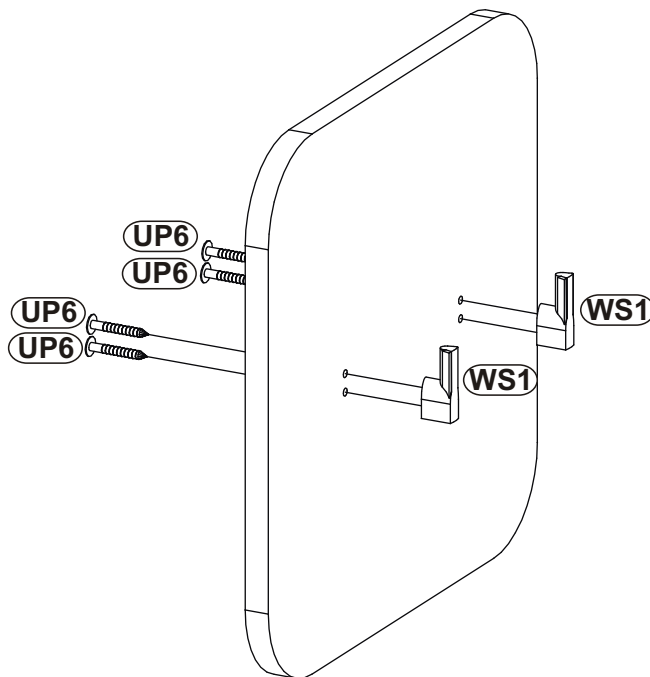

3

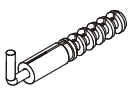
KR2	
x3	Ø8

