

# EASY 20\_EY TYP 01

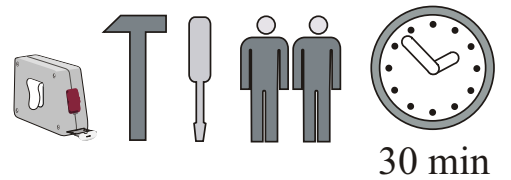

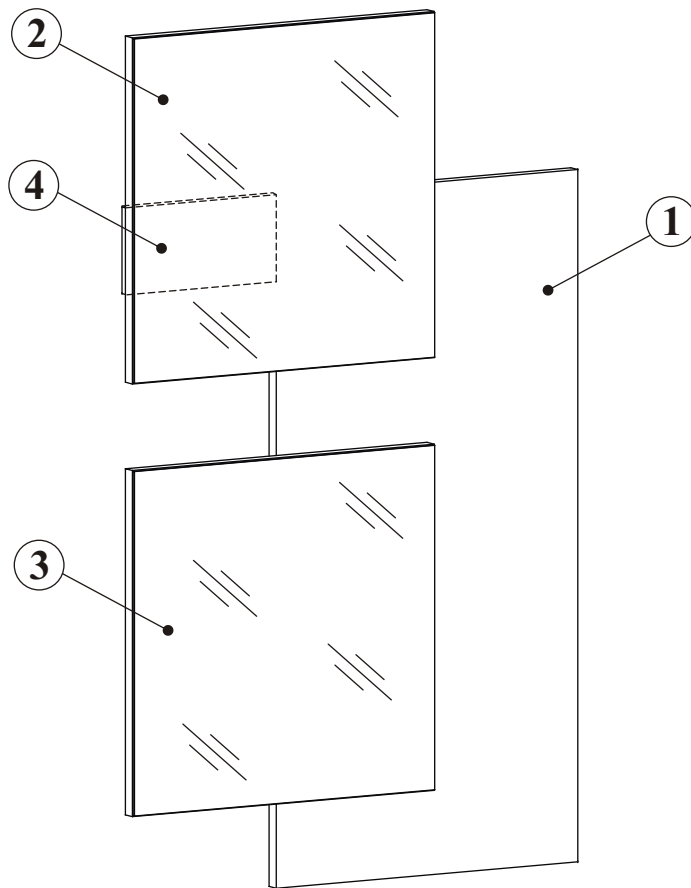

NO	Dim.			Col.-No	Qty
1	400	800	16	1	1
2	400	400	19	1	1
3	400	400	19	1	1
4	195	100	16	1	1

EASY 20\_EY TYP 01

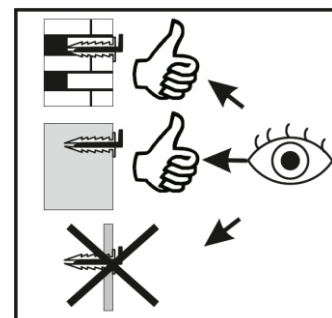
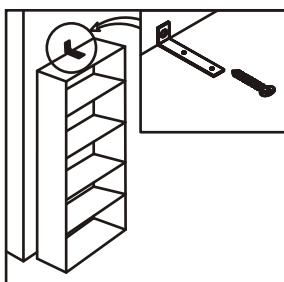
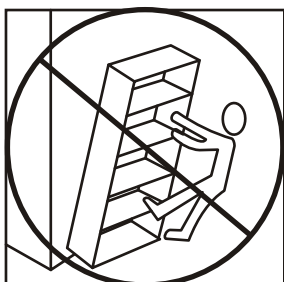
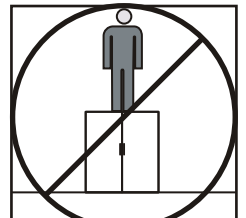
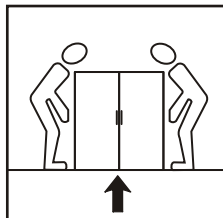
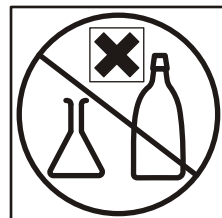
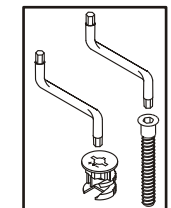
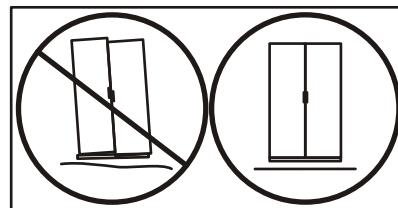
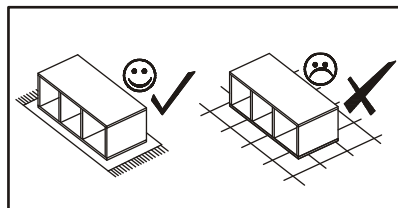
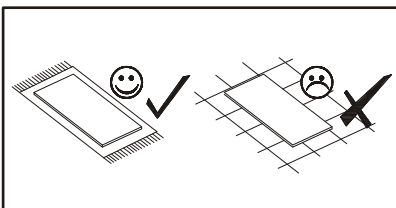
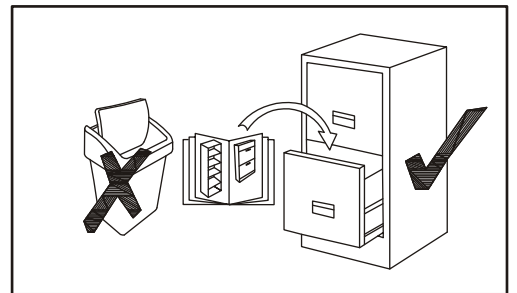
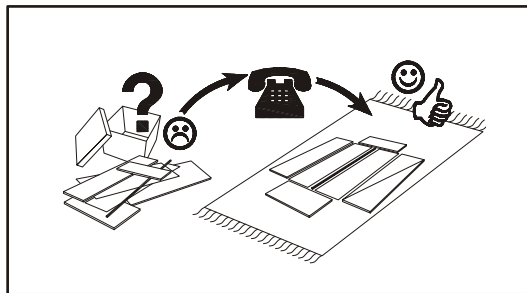
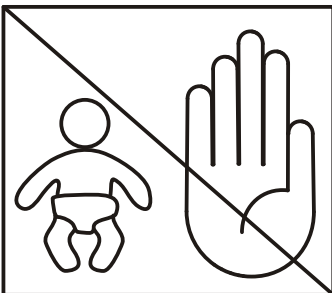
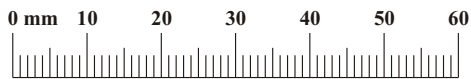
A3 x2 Ø8x47	B6 x1 Ø7x76	B5 x2 Ø15x12	G5 x2	ZM1 x3	D20 x6 ESØ6x9,5
D6 x7 USØ3,5x30	KR3 x3 Ø10	G2 x1			

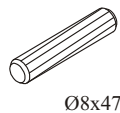

A3	
x2	Ø8x47

B5	
x2	Ø15x12

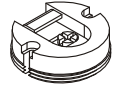
ZM1	
x3	

D20	
x6	ESØ6x9,5

1

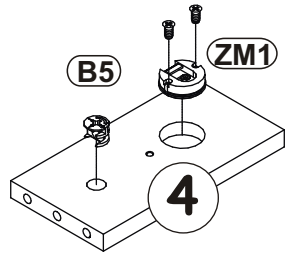
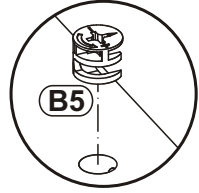
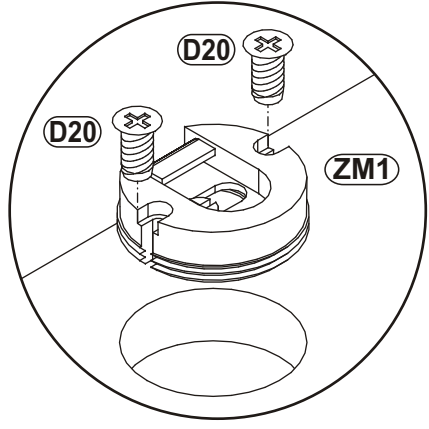
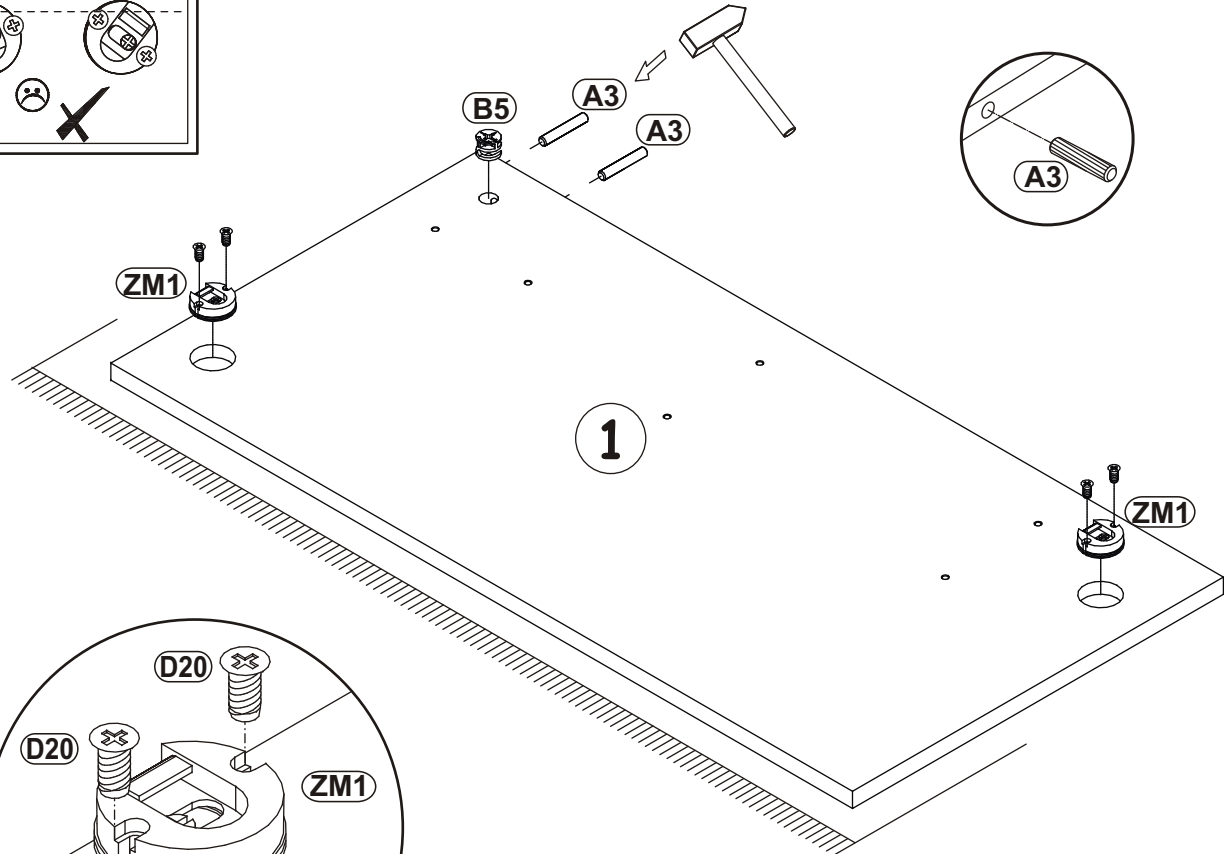
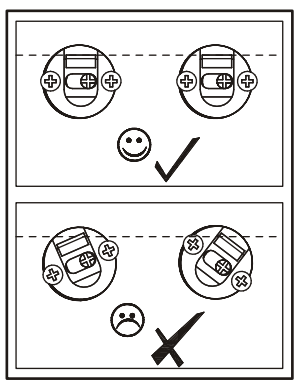

2

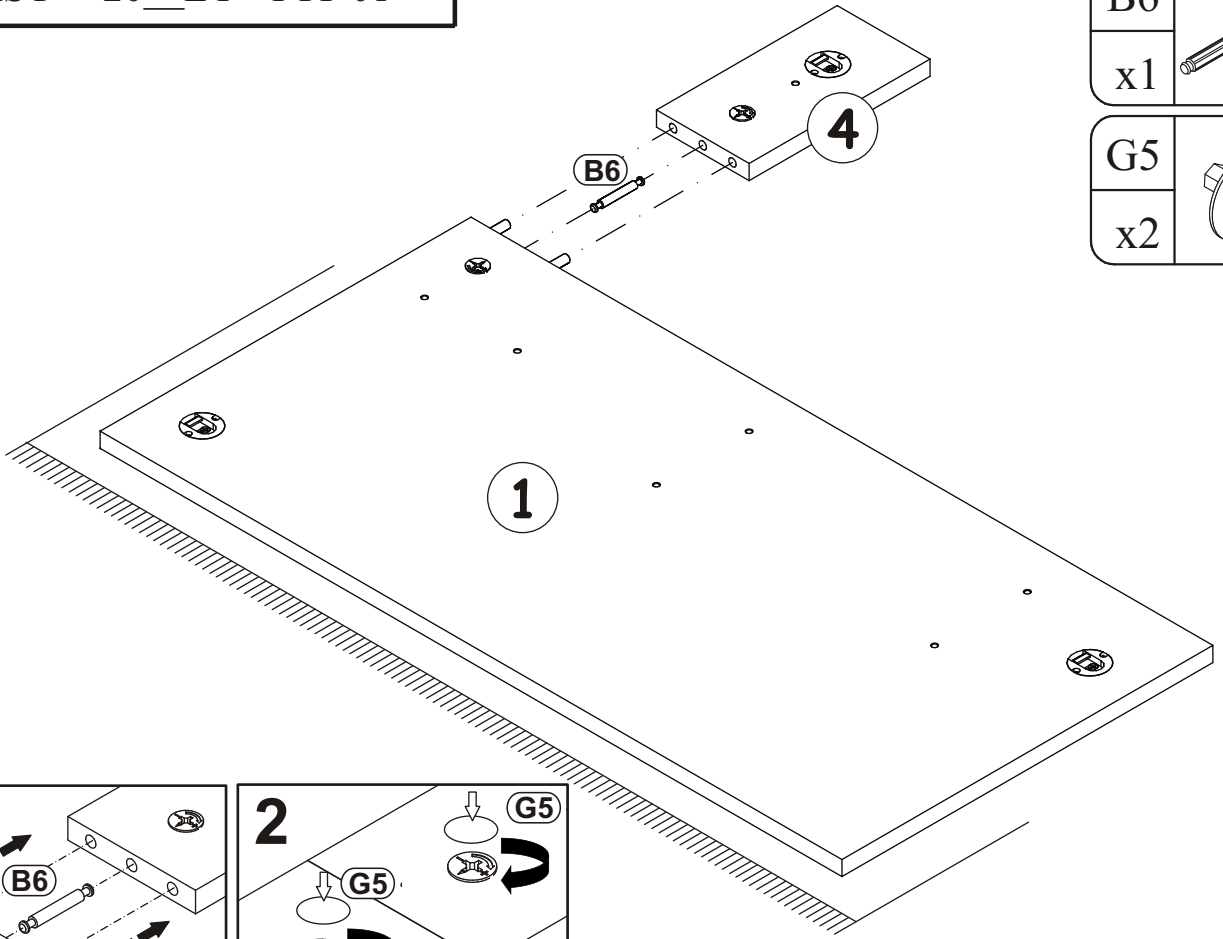

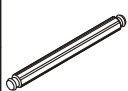
B6	
x1	Ø7x76

G5	
x2	

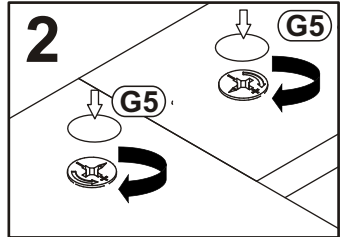
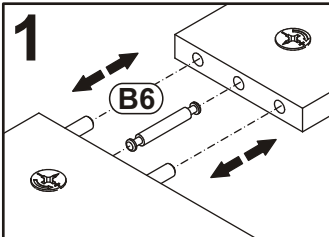

3

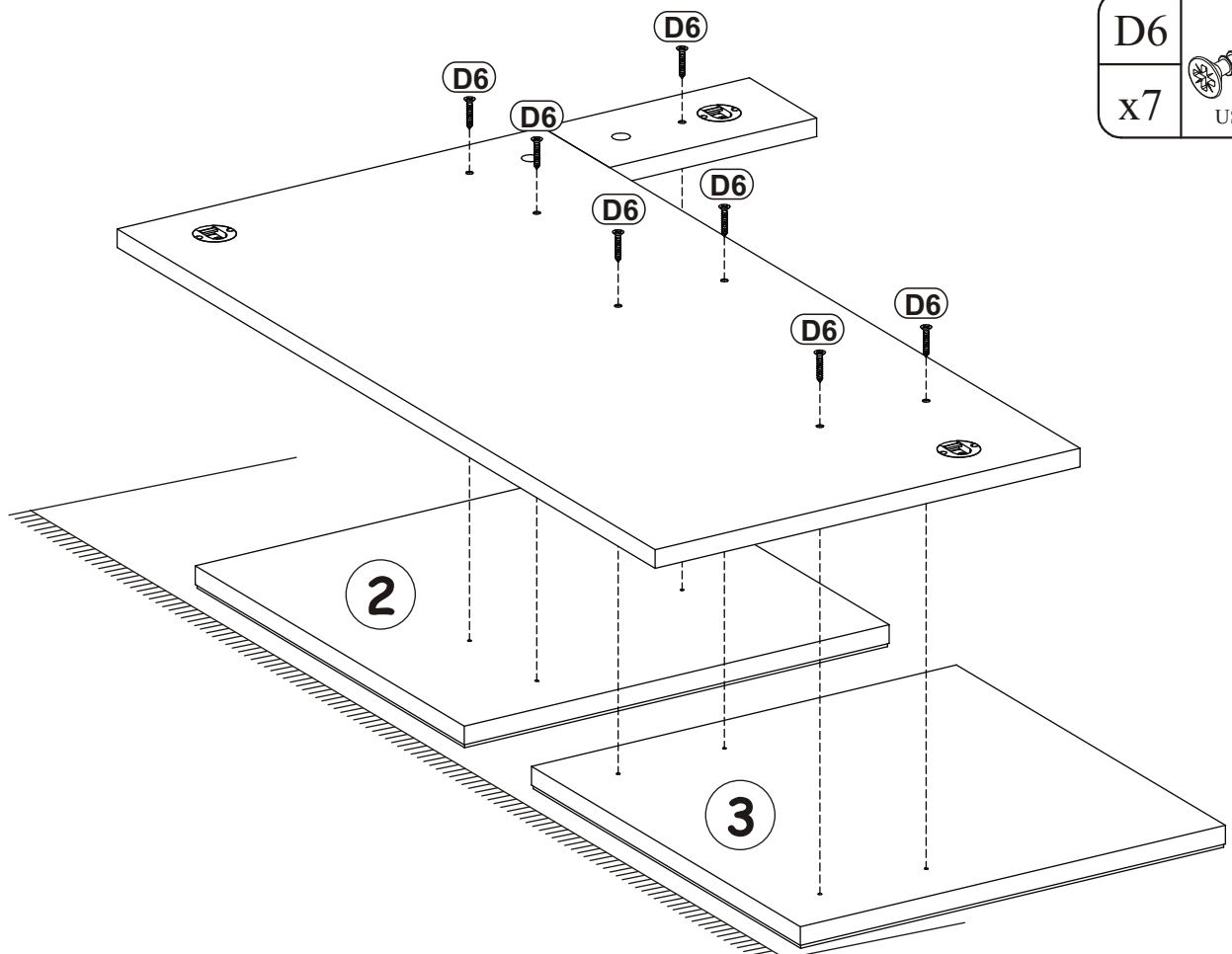

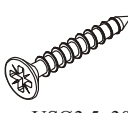
D6	
x7	USØ3,5x30

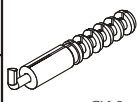
KR3	
x3	Ø10

4

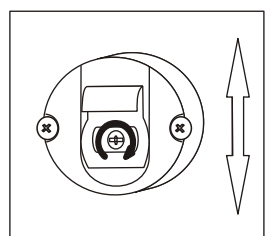
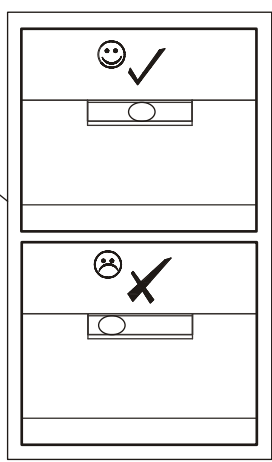
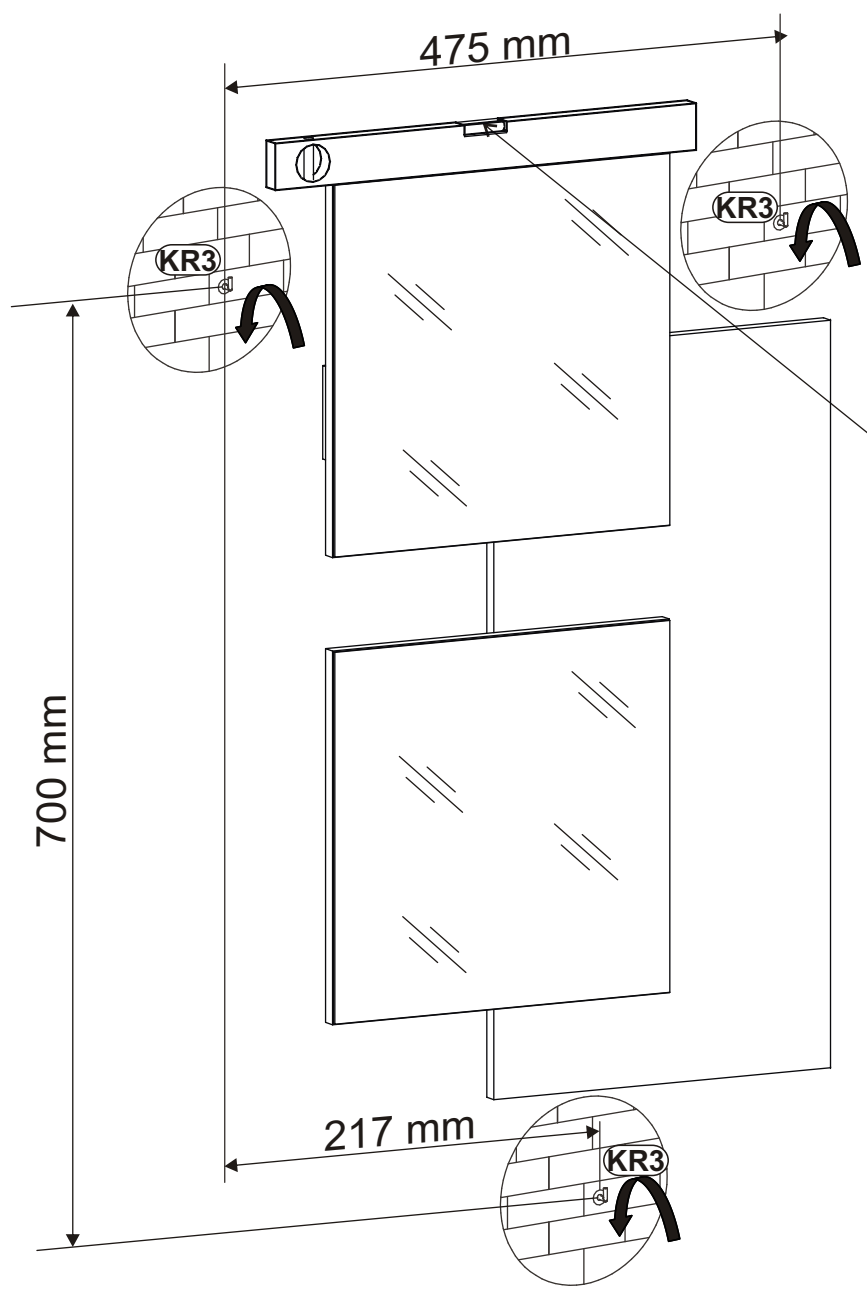
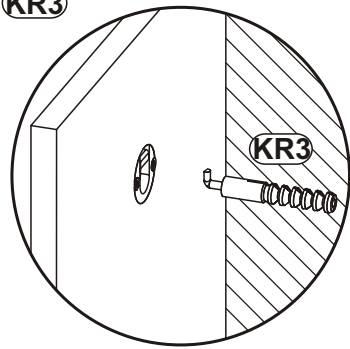
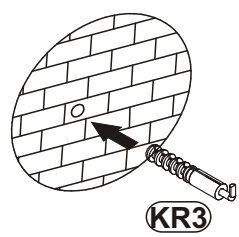
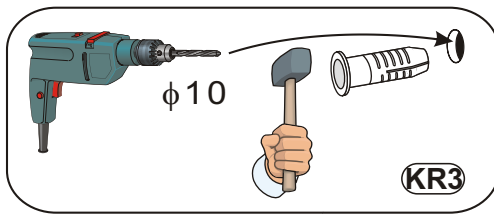
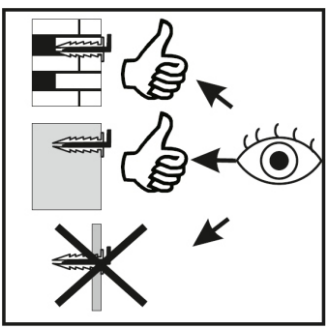

# EASY 20\_EY TYP 02

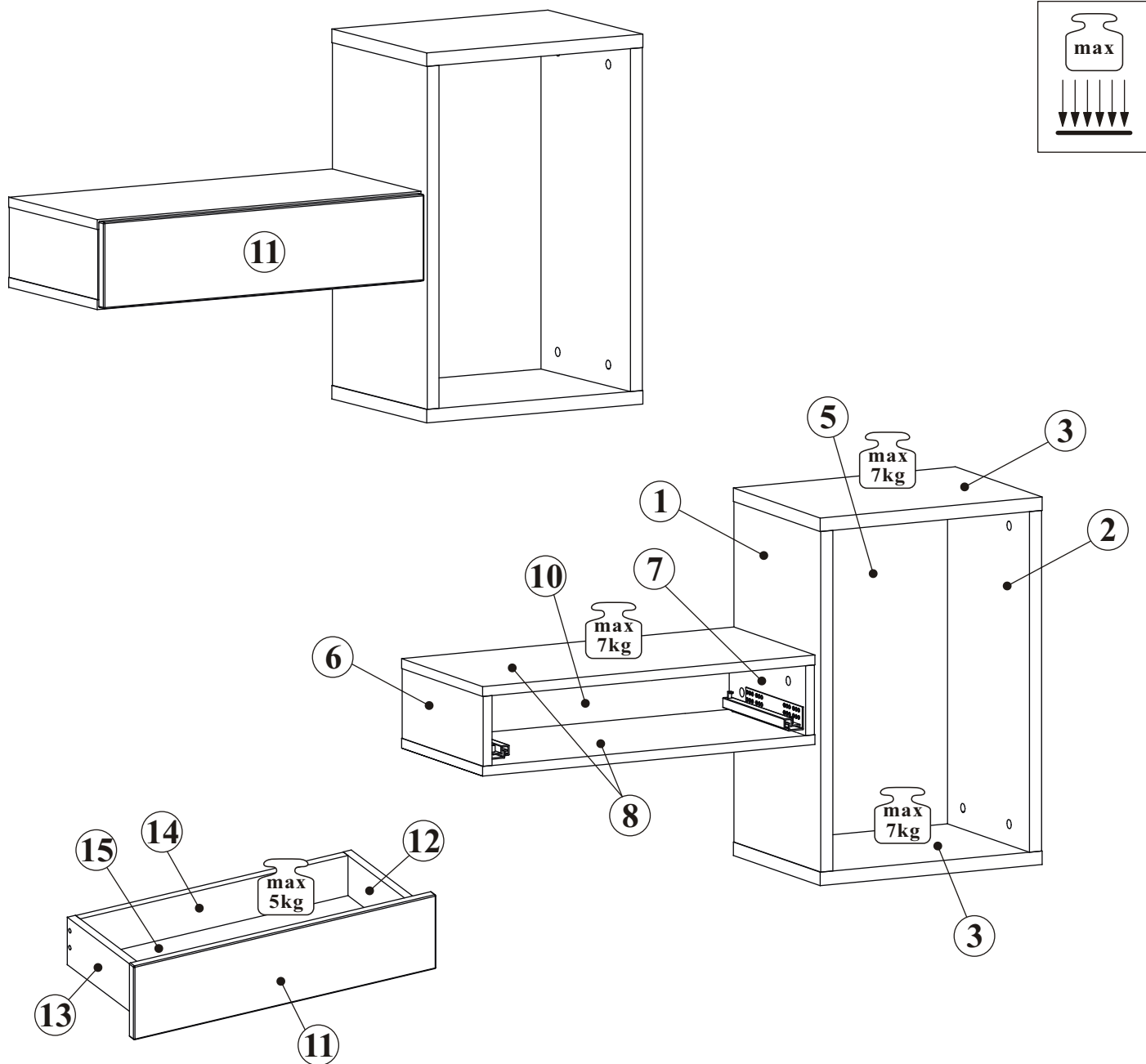

NO	Dim.			Col.-No	Qty
1	556	300	22	1	1
2	556	300	22	1	1
3	402	300	22	1	2
5	556	356	16	1	1
6	114	280	16	1	1
7	114	280	16	1	1
8	602	280	16	1	2
10	568	114	16	1	1
11	596	140	16	1	1
12	250	90	16	1	1
13	250	90	16	1	1
14	528	76	16	1	1
15	254	540	3	1	1

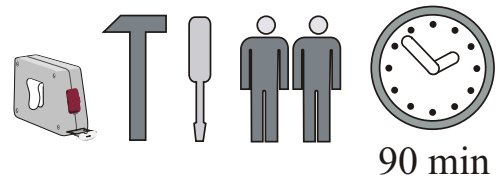



# EASY 20\_EY TYP 02

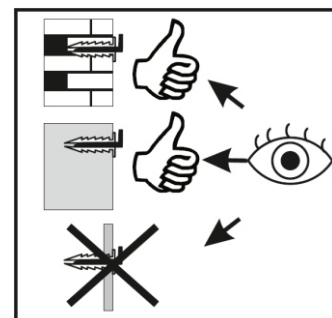
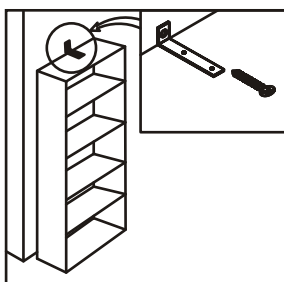
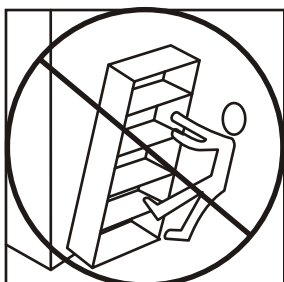
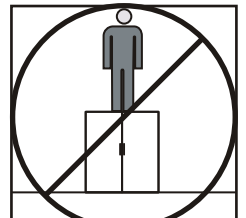
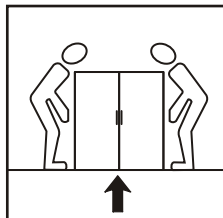
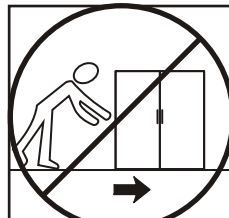
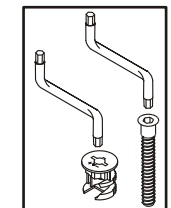
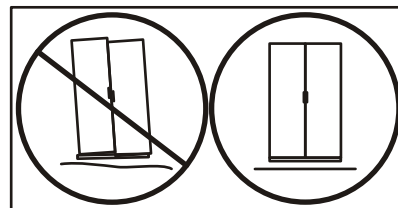
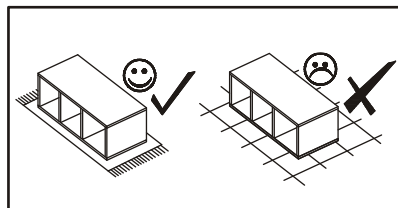
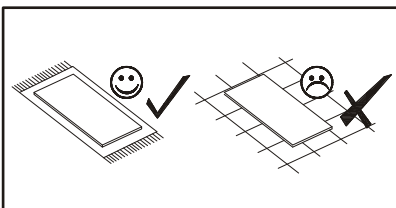
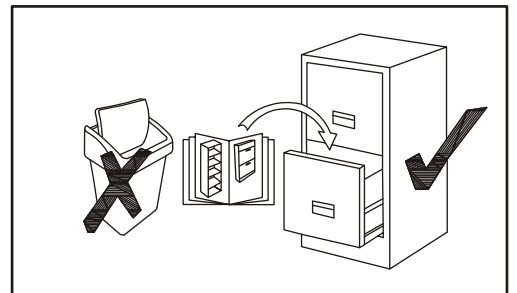
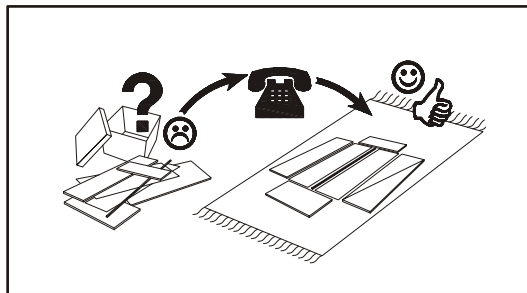
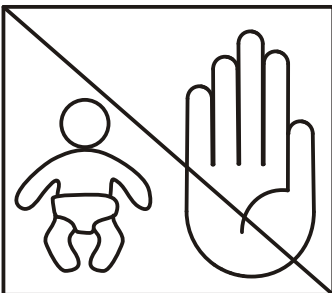
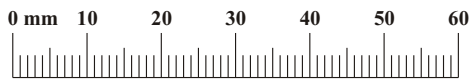

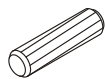
A1 x32 ø8x36	B4 x28	B5 x20 Ø15x12	B16 x8 Ø15x16	G5 x28	B11 x4 Ø7x50
QU x1 L-250mm	D20 x12 ESØ6x9,5	D10 x4 USØ3,5x13	KR3 x4 Ø10	ZM1 x4	G4 x4
S1 x1	UP13 x5 UPØ3x16	G2 x1			

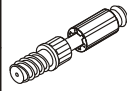

A1	
x8	ø8x36

B4	
x2	

B16	
x8	Ø15x16

12mm	
16mm	
	B5 B16

1

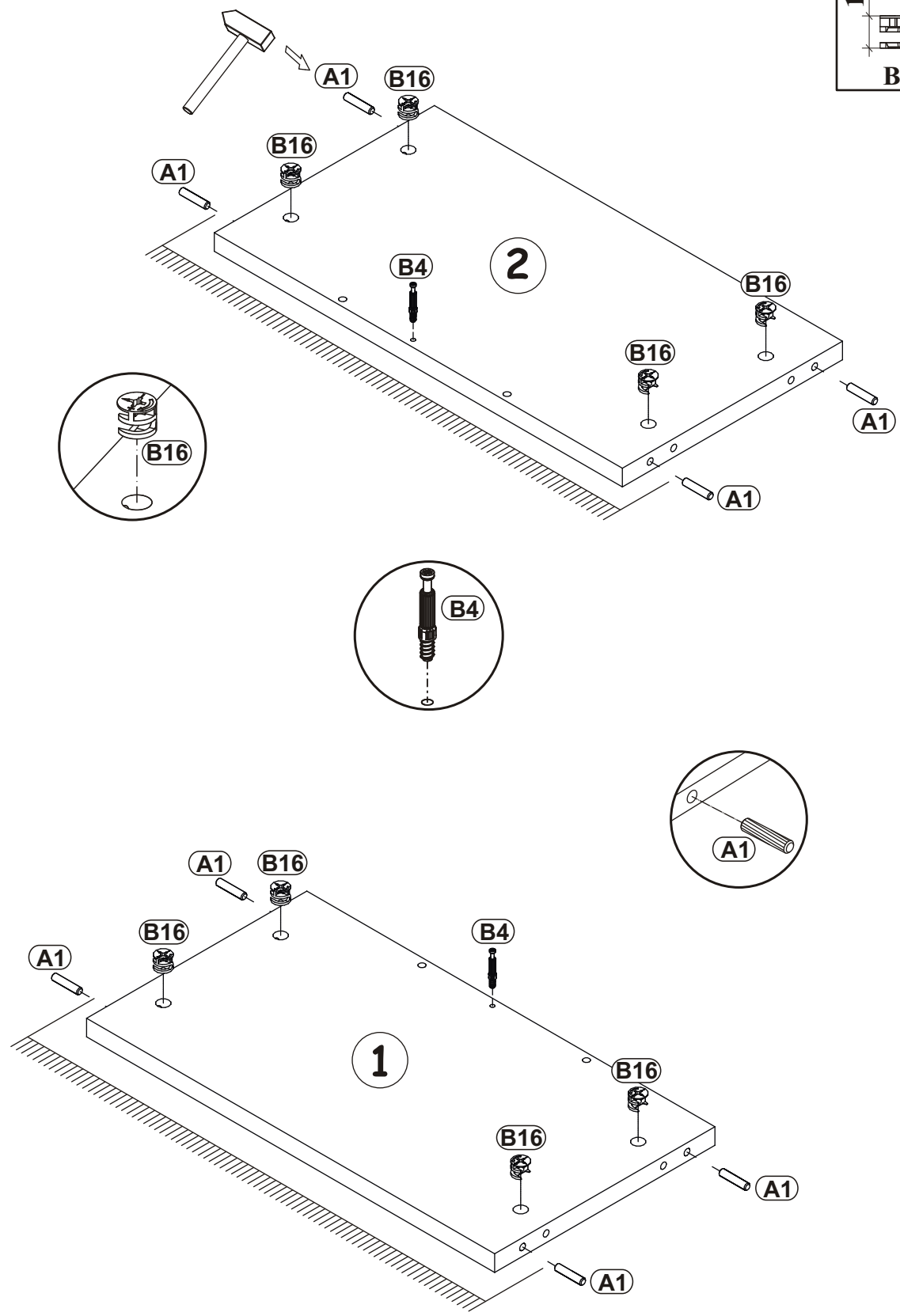



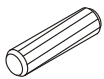

2

A1	
x14	ø8x36

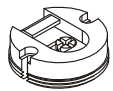
B5	
x10	Ø15x12

ZM1	
x4	

12mm		16mm	
	B5		B16

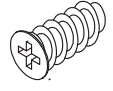

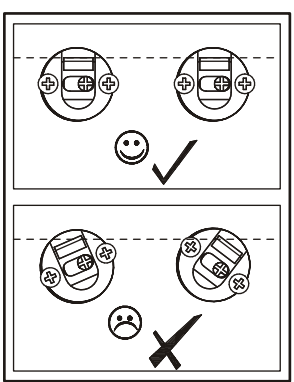
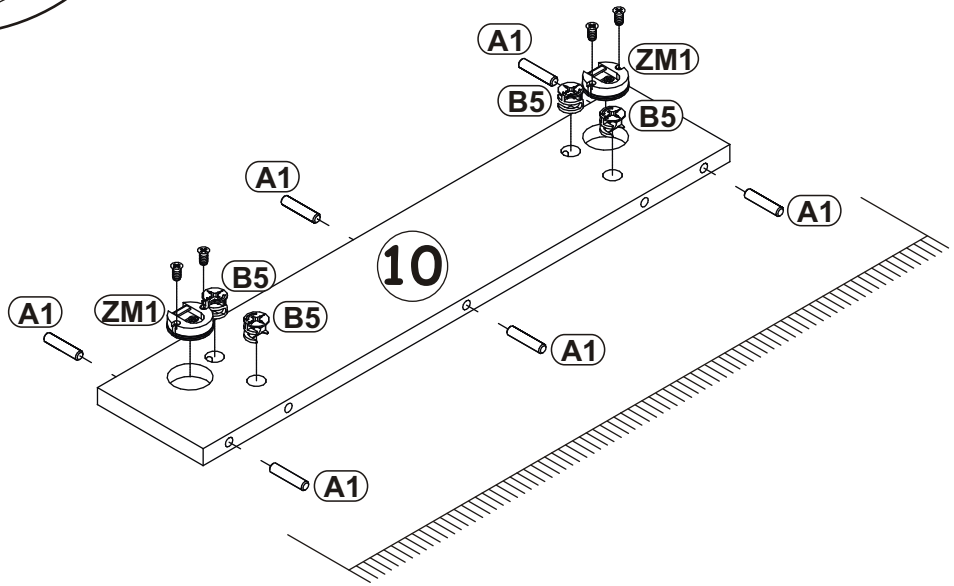
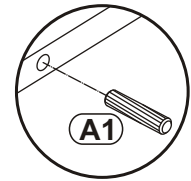
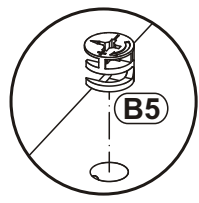
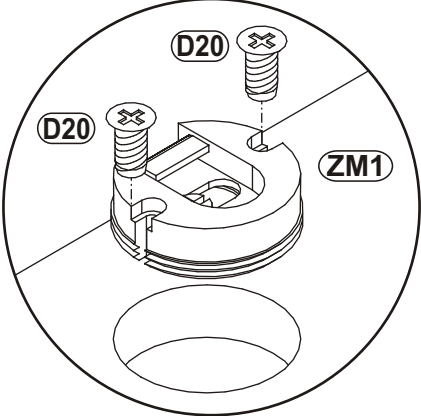
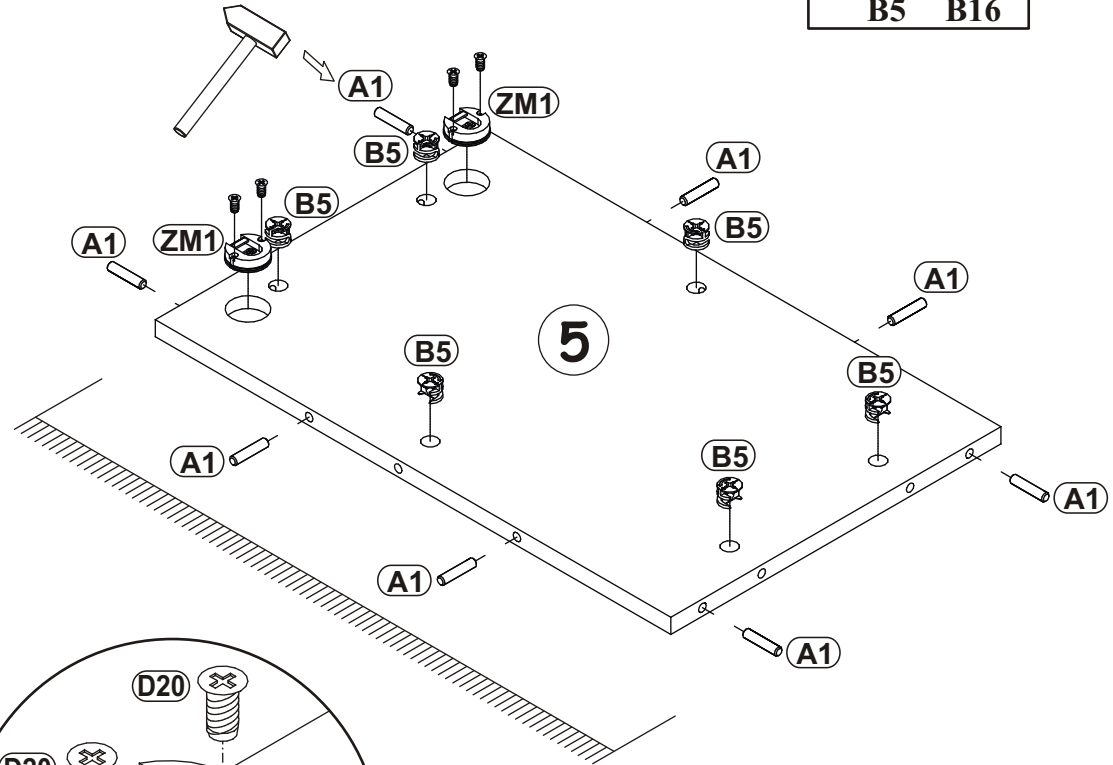
D20	
x8	ESØ6x9,5

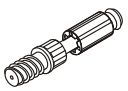

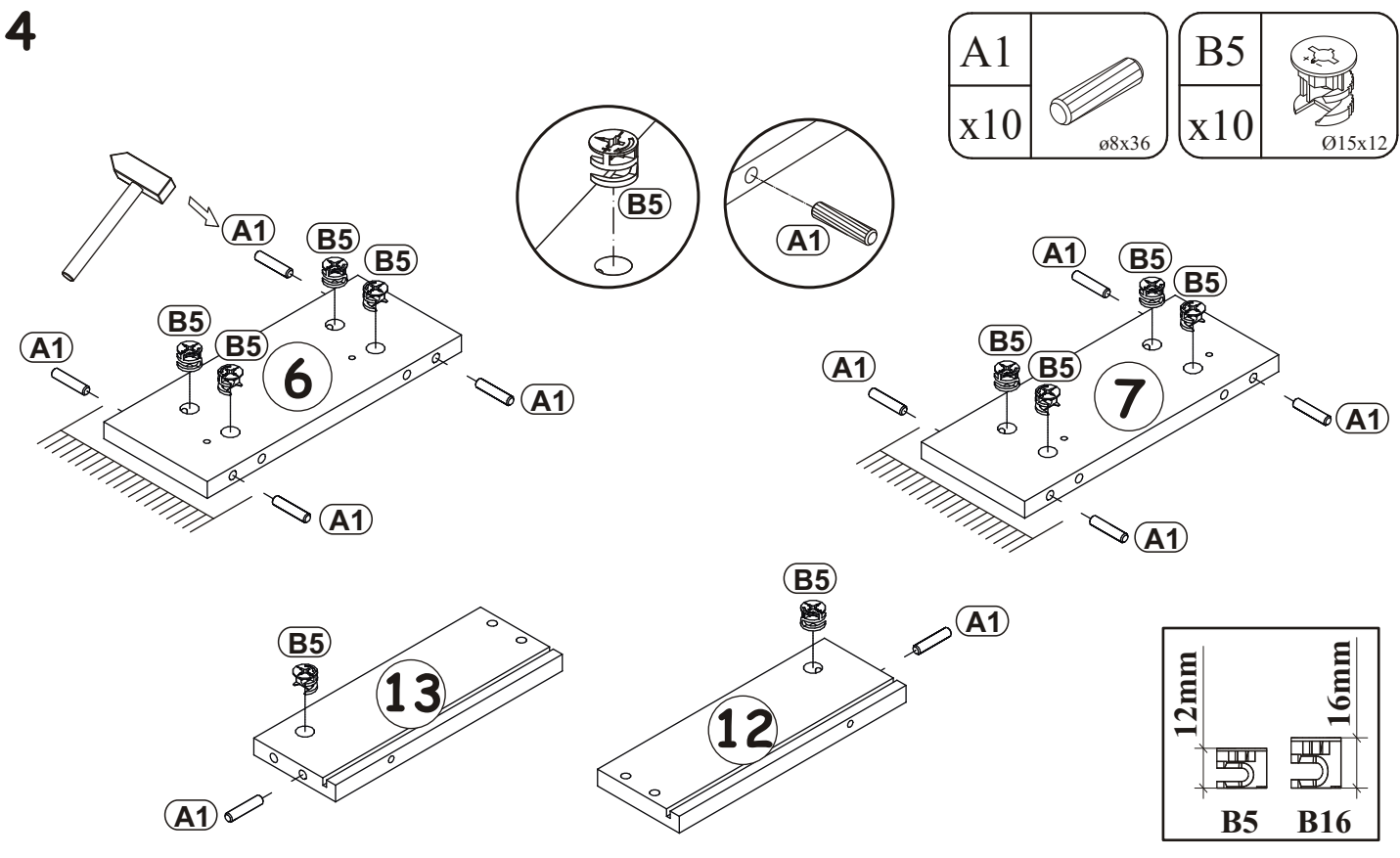
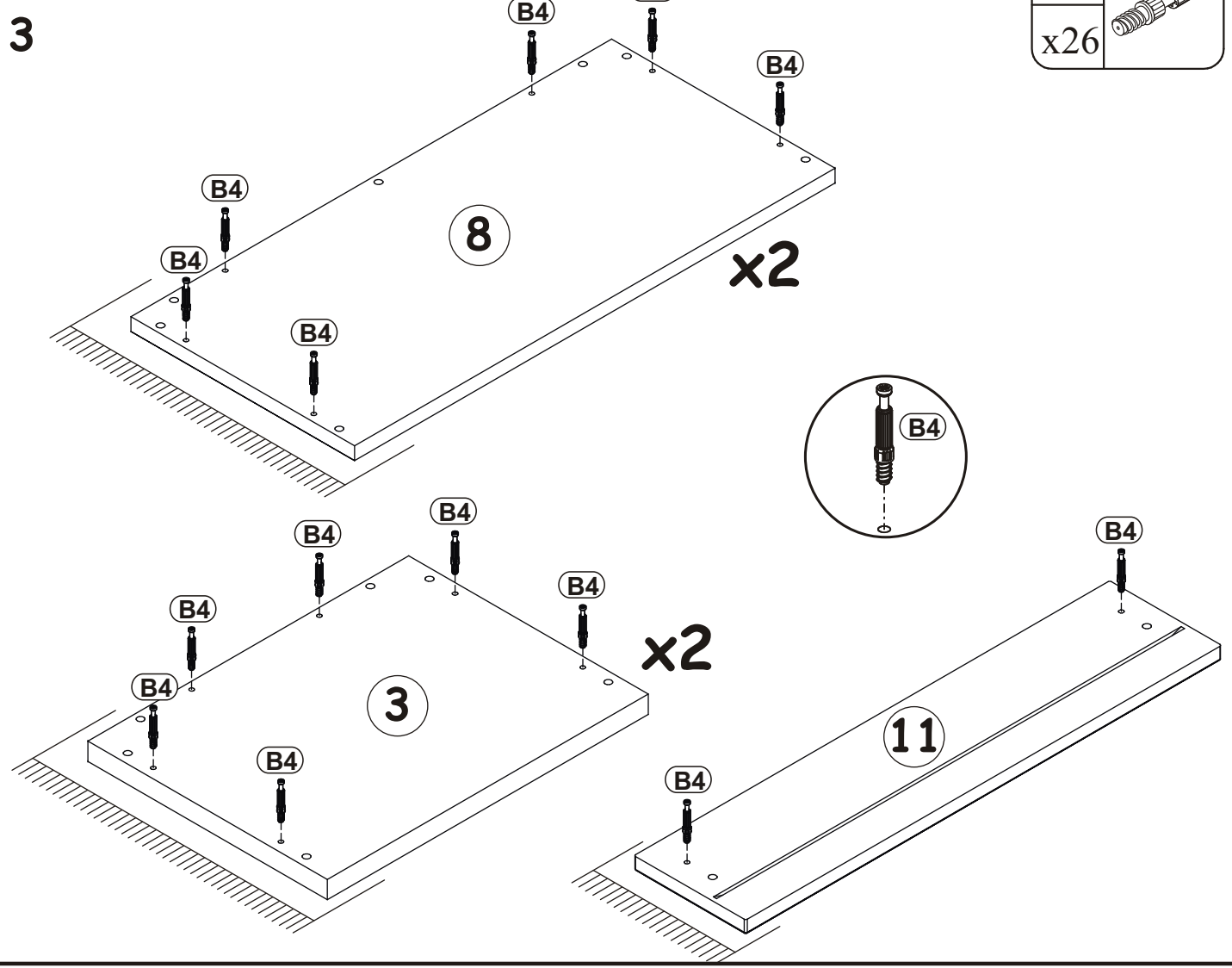
B4	
x26	

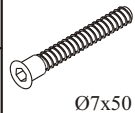

5

B11		G4	
x4	Ø7x50	x4	

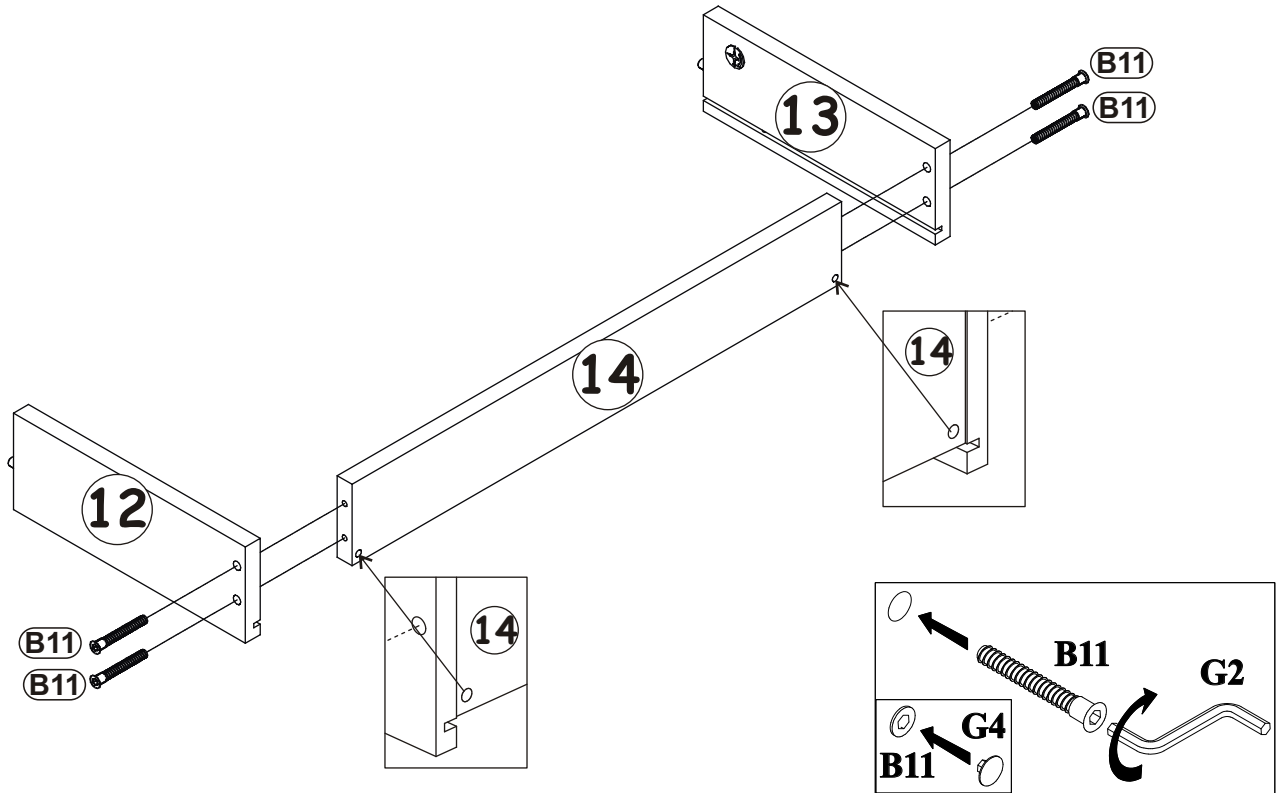

6

G5	
x2	

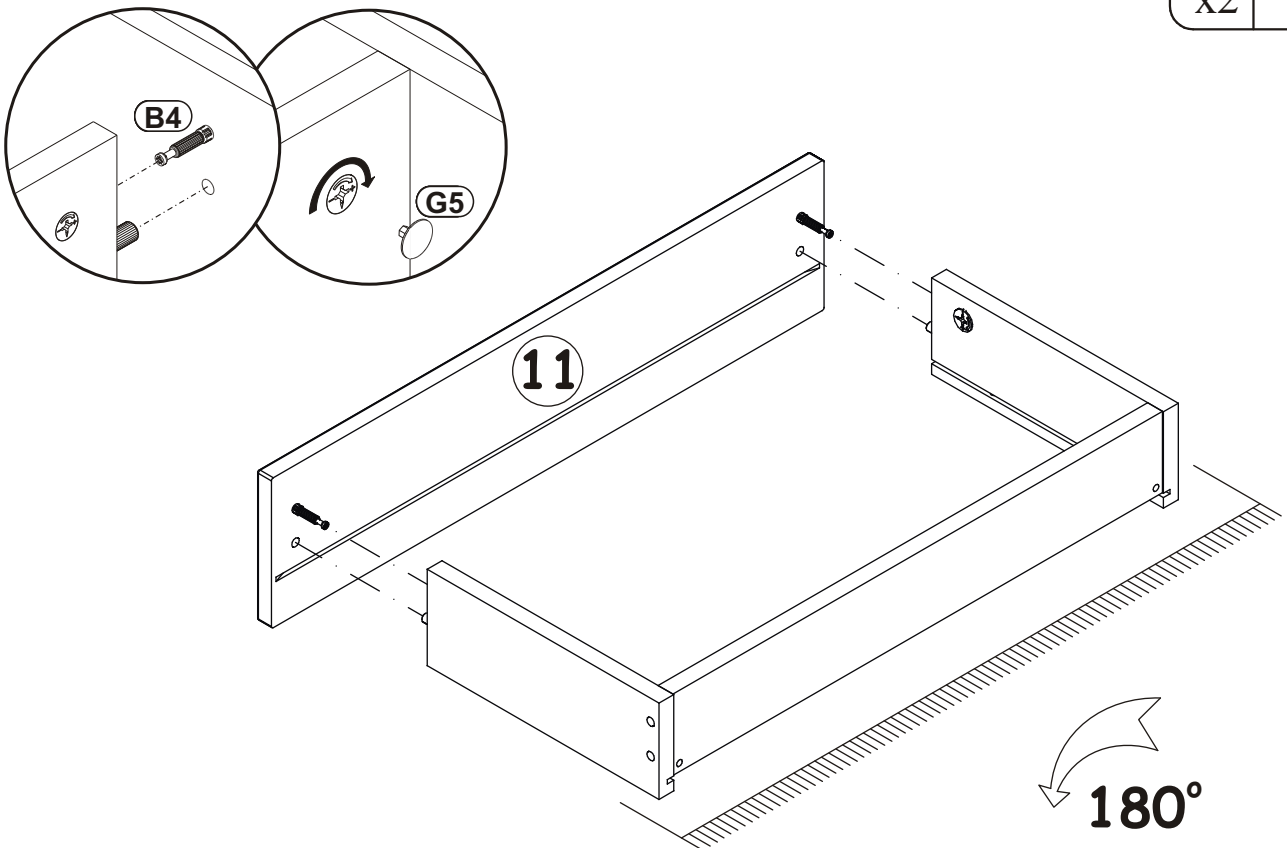

7

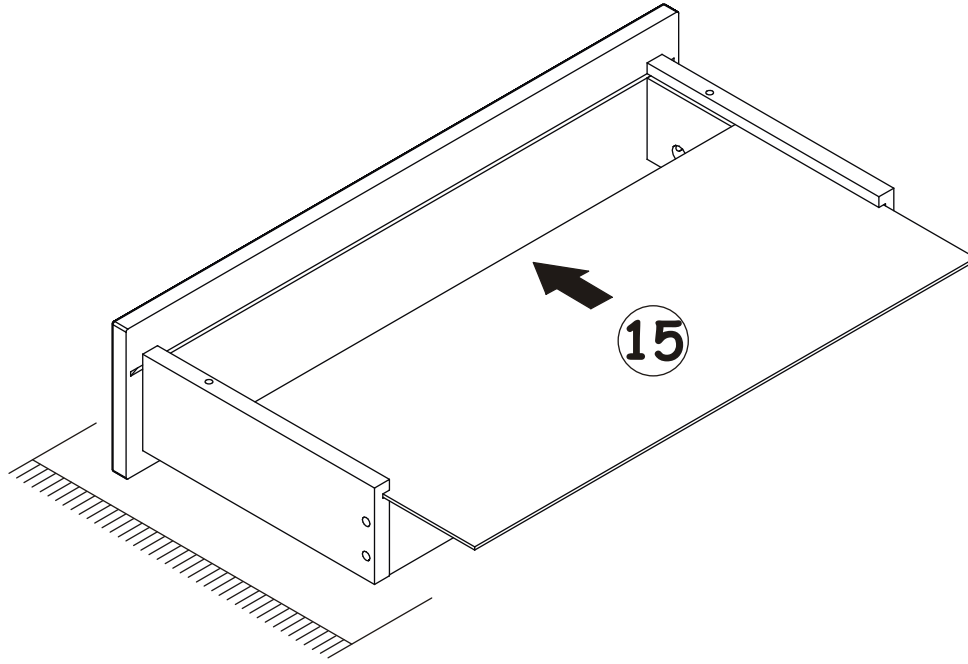

8



S1		UP13	
x1		x5	UPØ3x16

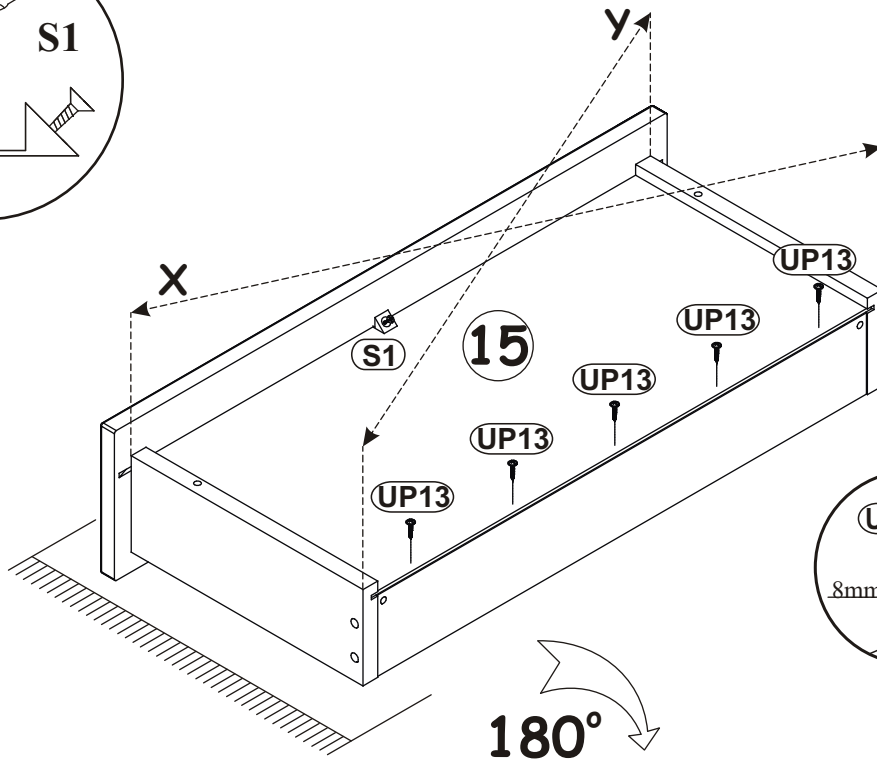
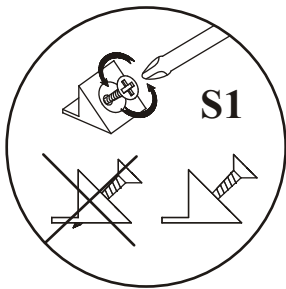

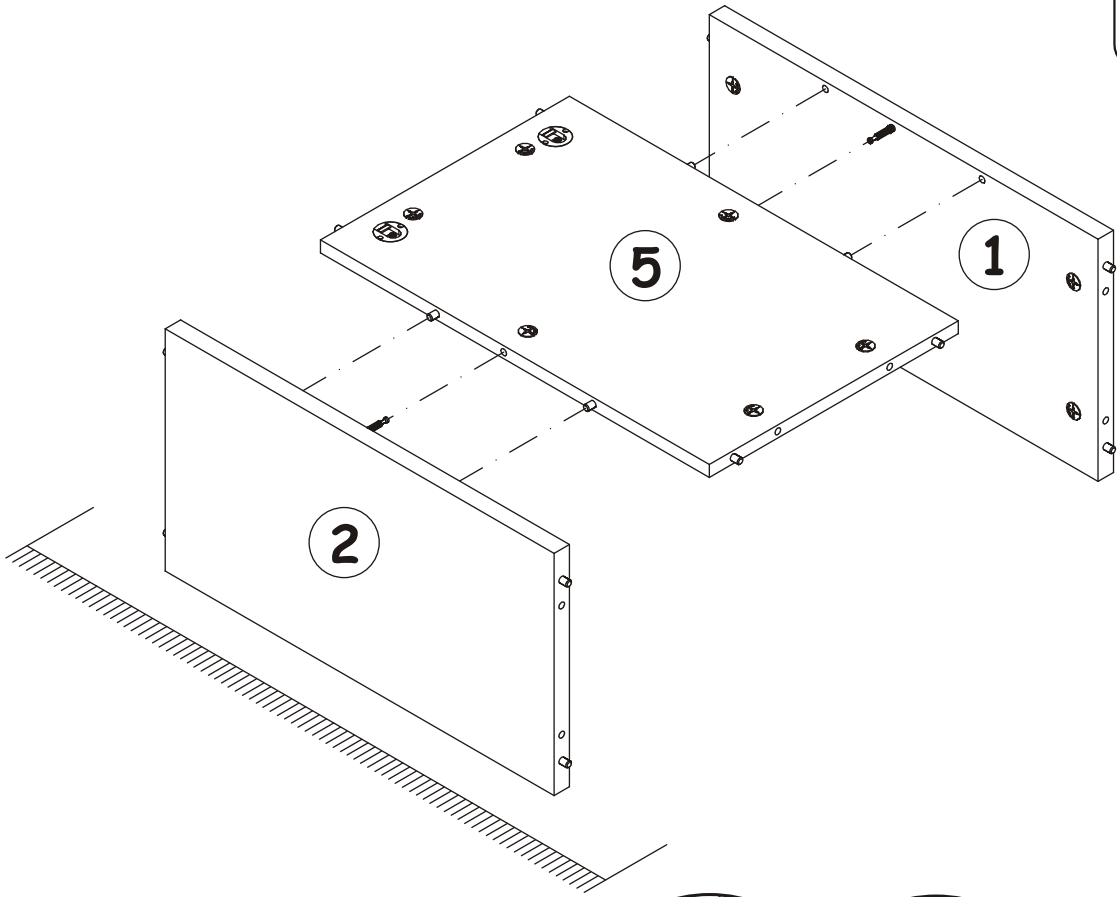

G5	
x2	

9

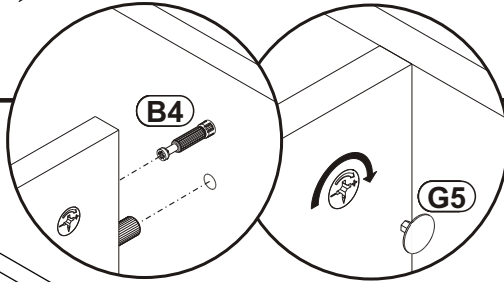

10



G5	
x12	

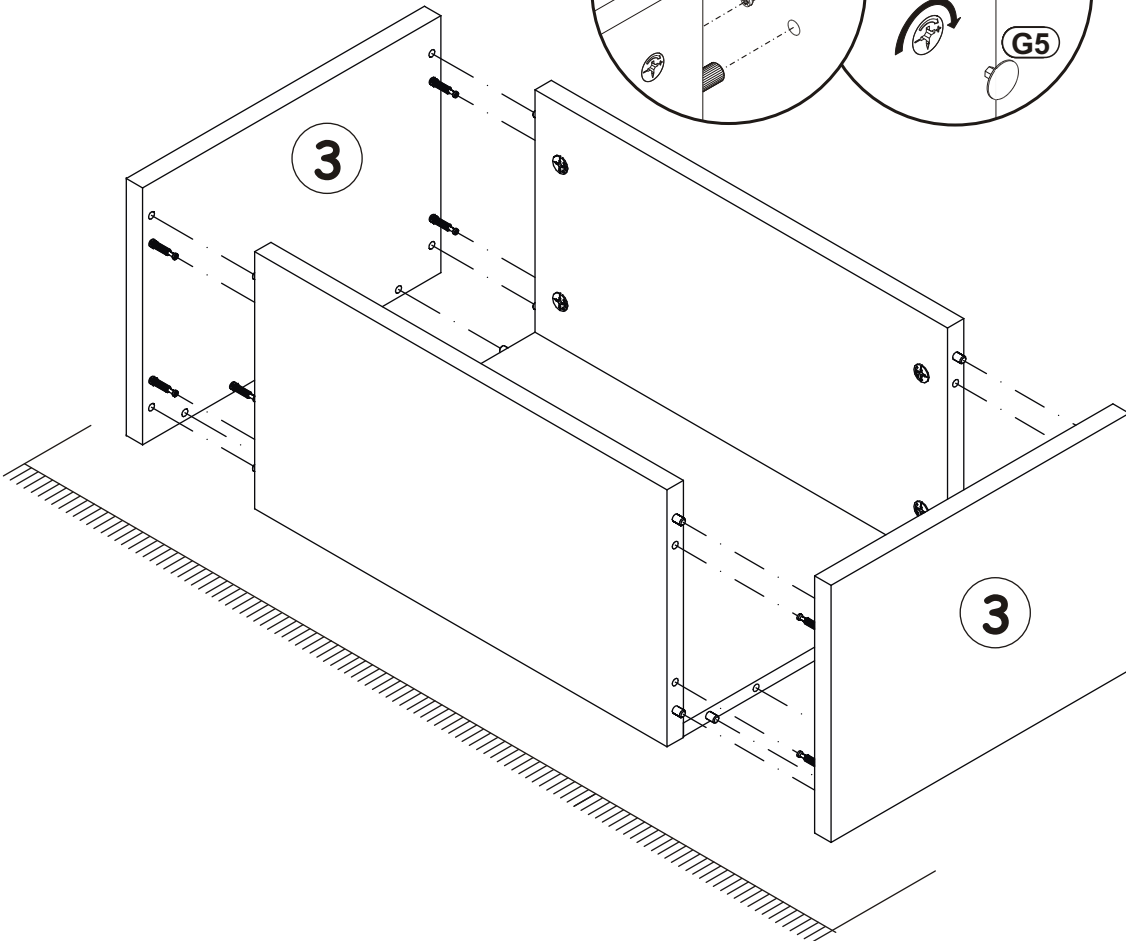

G5	
x12	

11

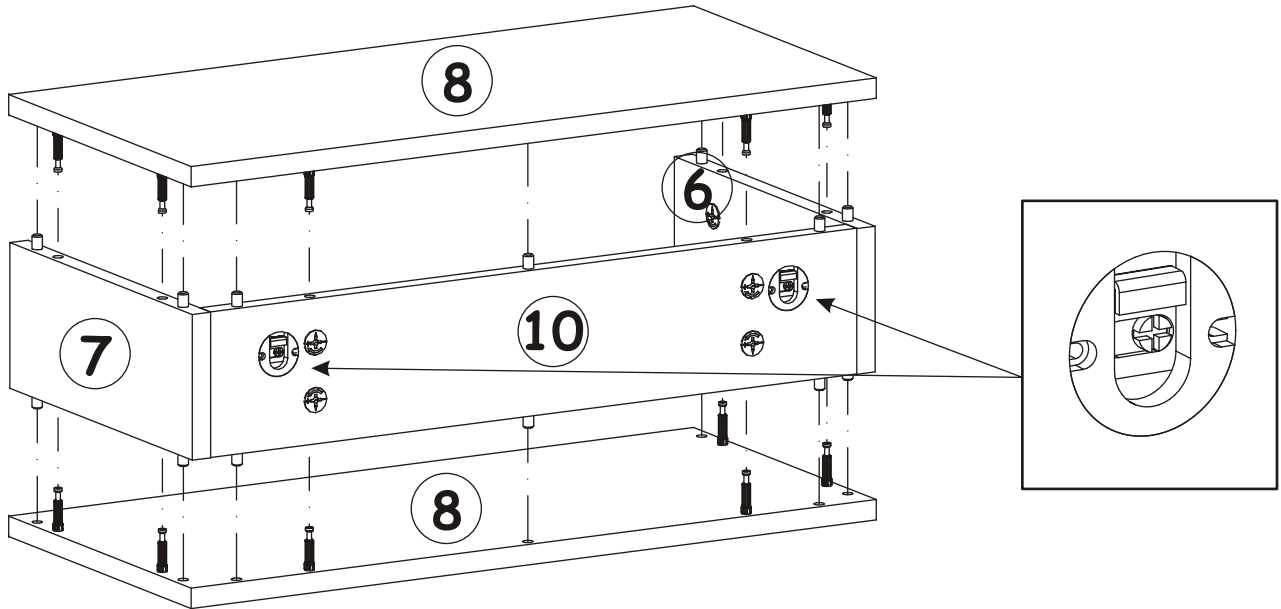
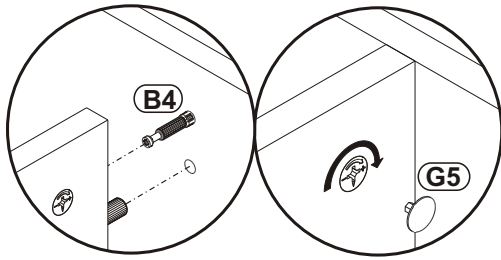

12

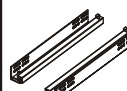
QU	
x1	L-250mm

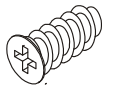
D20	
x4	ESØ6x9,5

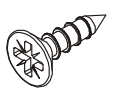
D10	
x4	USØ3,5x13

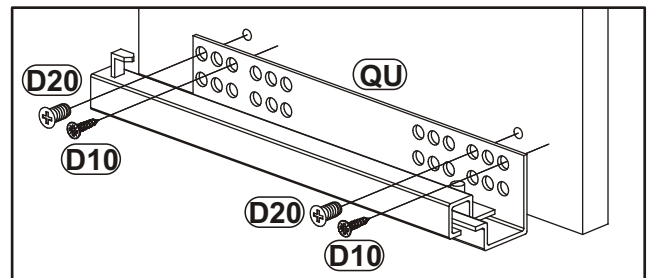
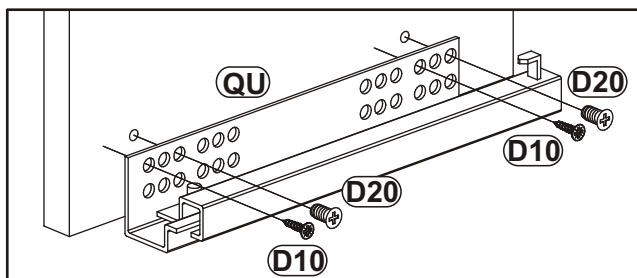
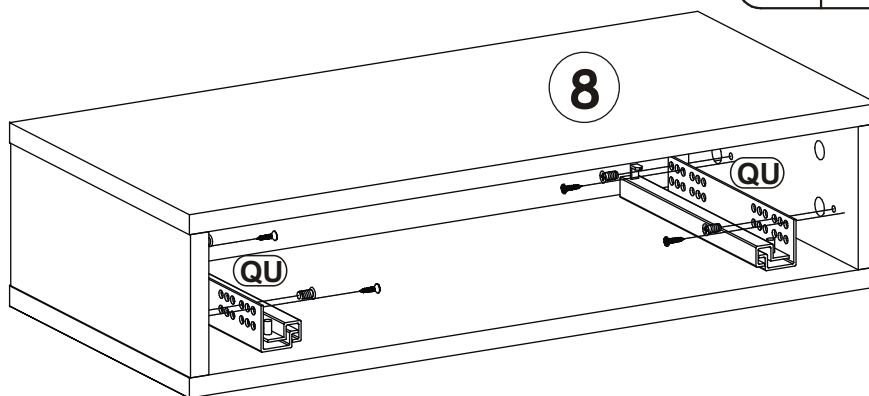

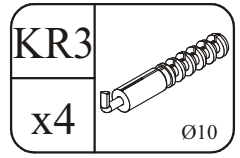

# 13

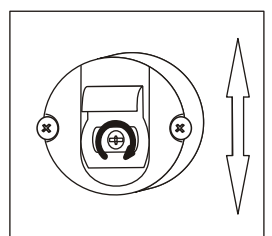
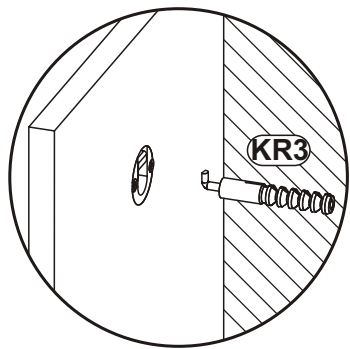
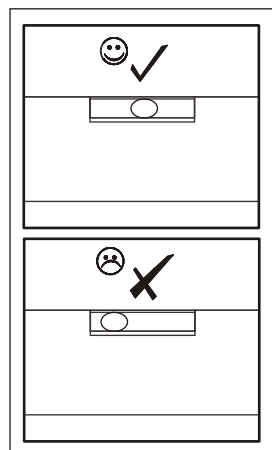
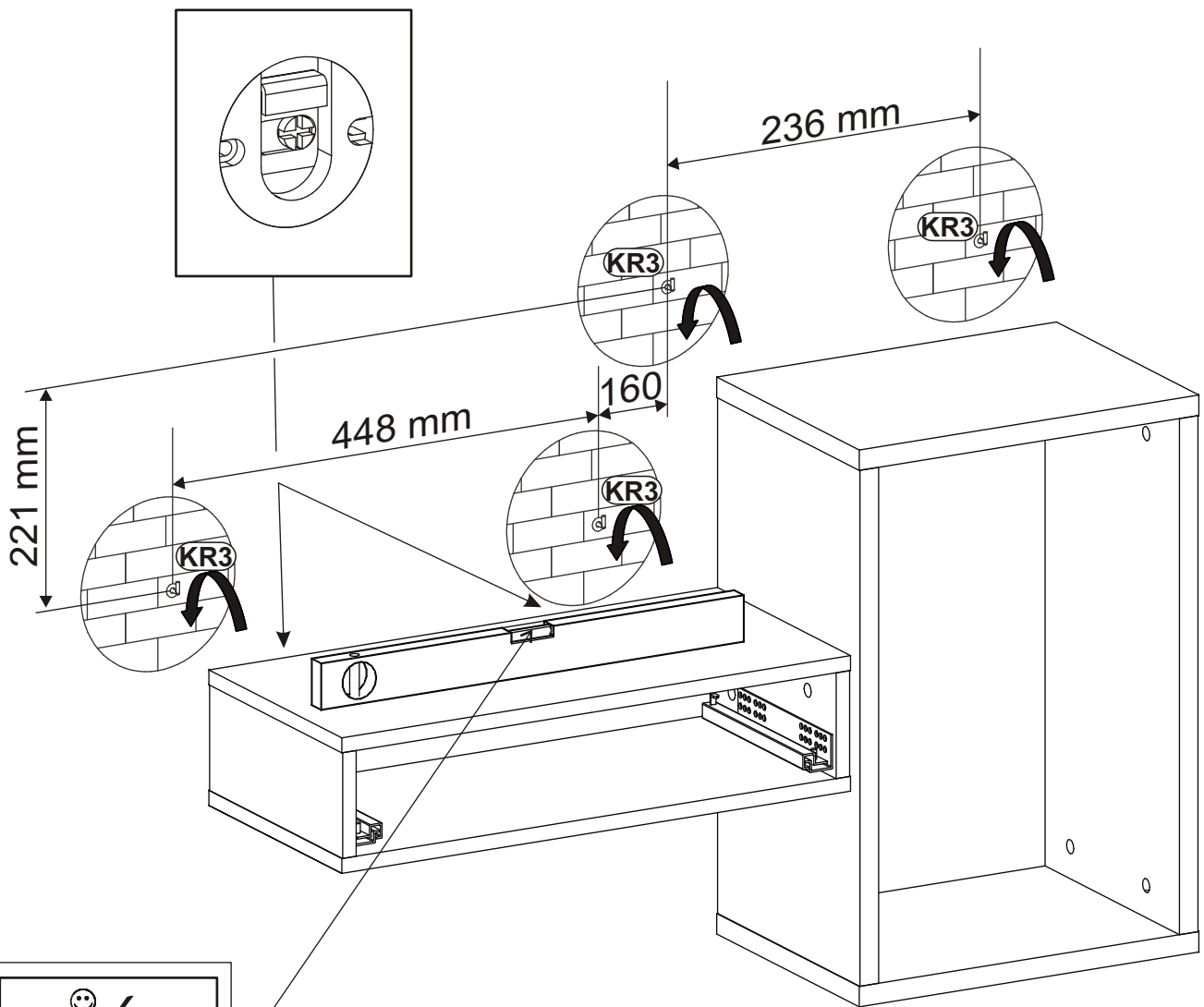
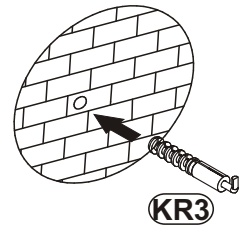
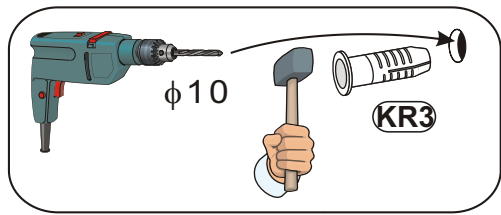
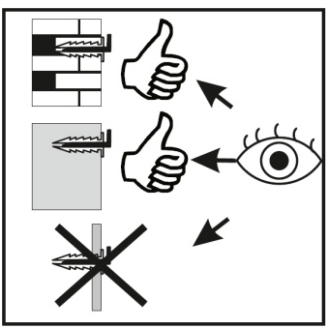

14

