

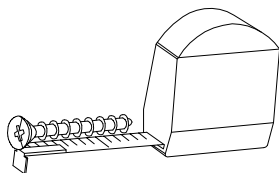

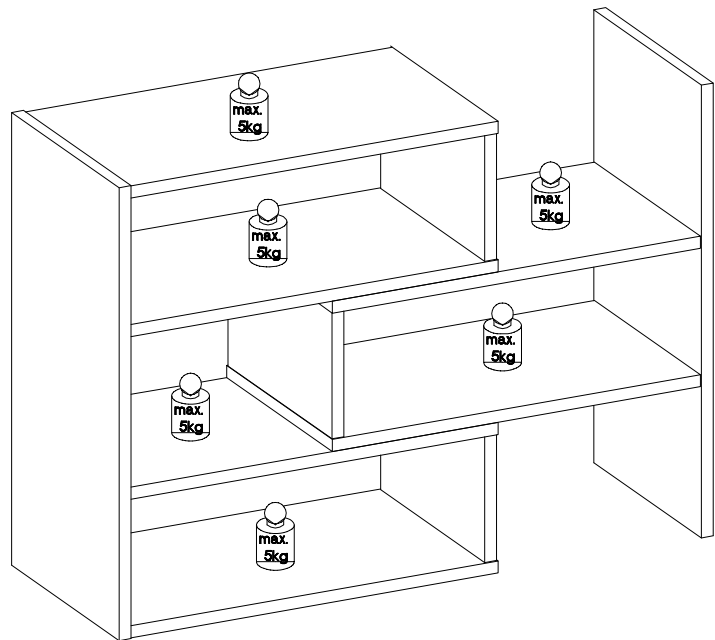

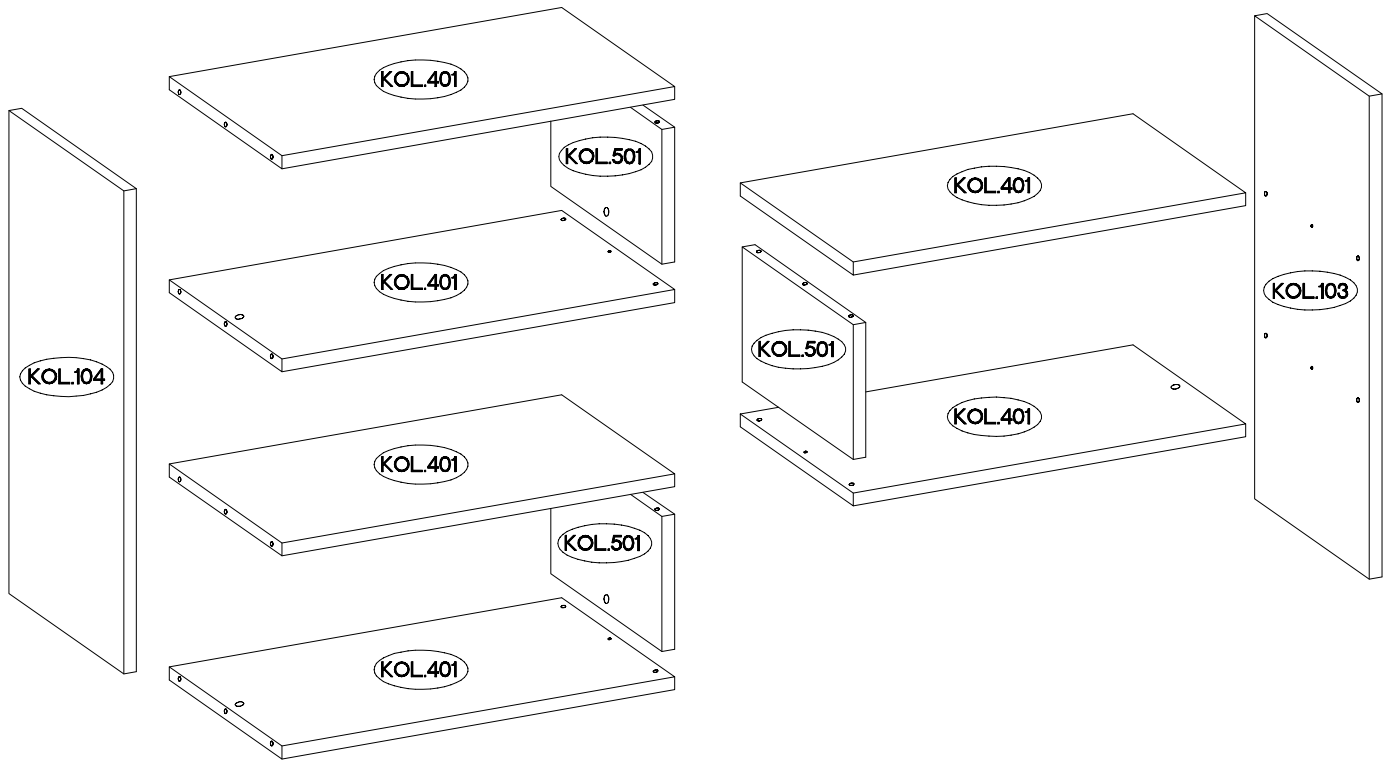

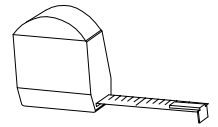

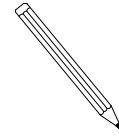
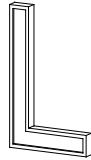
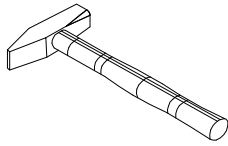
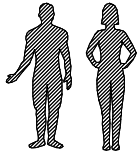





Regał KAROL 3



 P12 2	 O7 2	 L19 2	 P5 4		
 A 24	 D2 12	 C 12	 F4 6	 E 12	 O11 0,05

1.

 $\varnothing 8 \times 30 \text{ mm}$ A 24	 L=20mm D2 12	 $\varnothing 15 / 12 \text{ mm}$ C 12	 0,05 O11 1
--	---	--	---

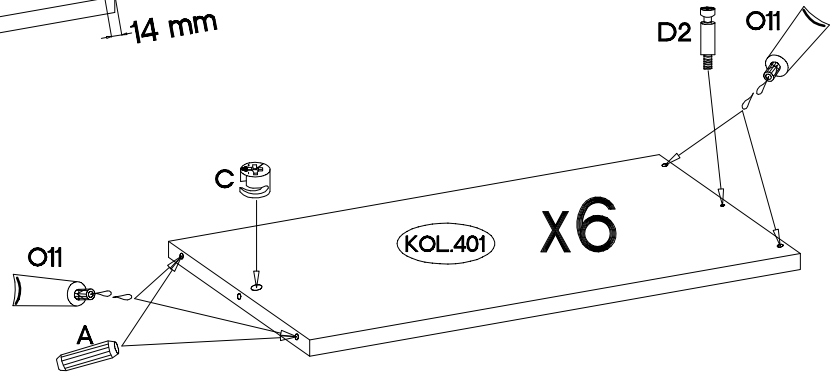
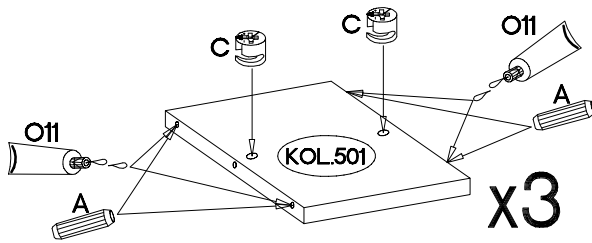
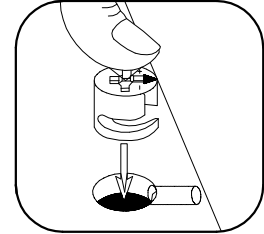
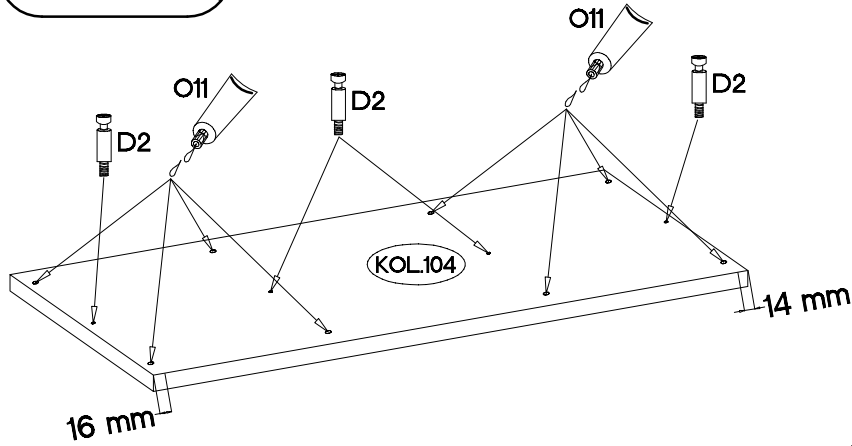
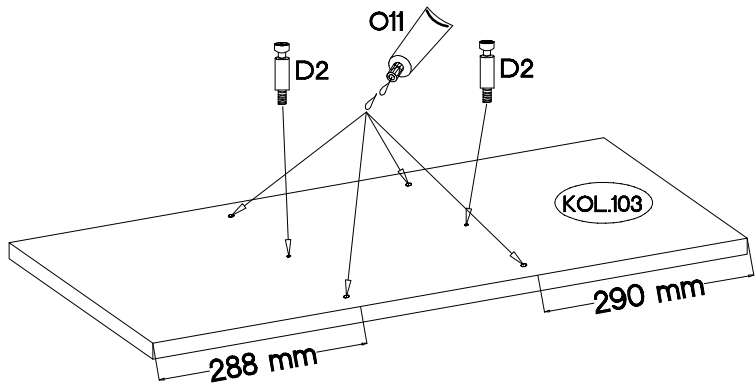
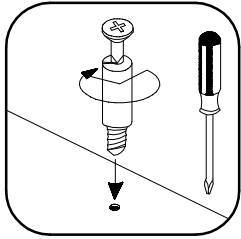

2.

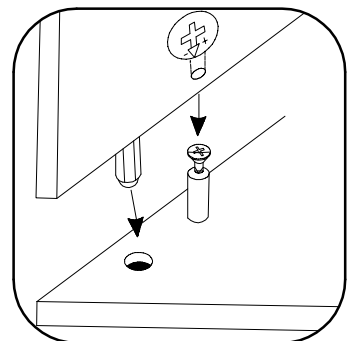
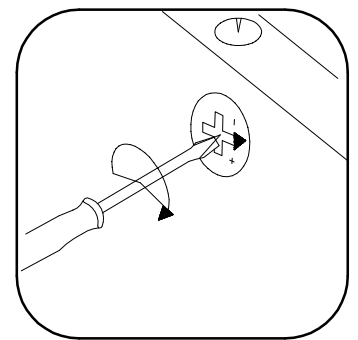
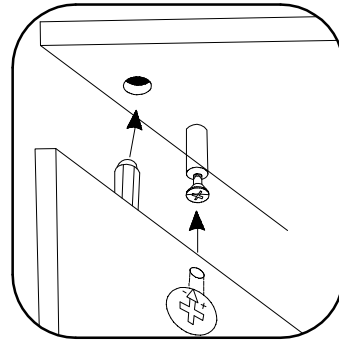
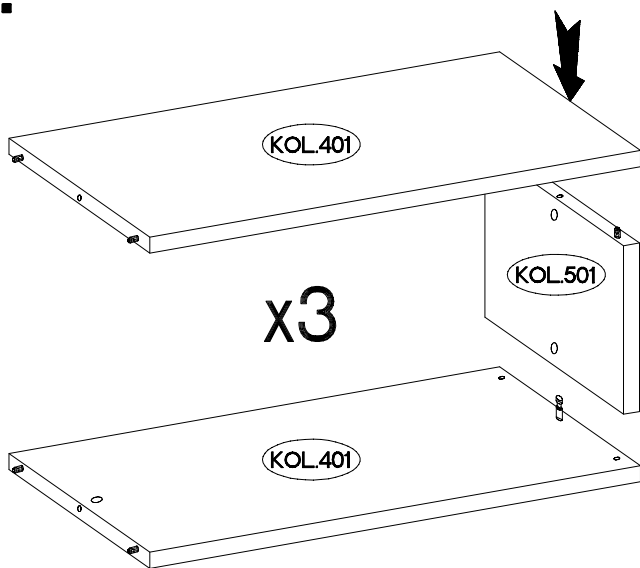



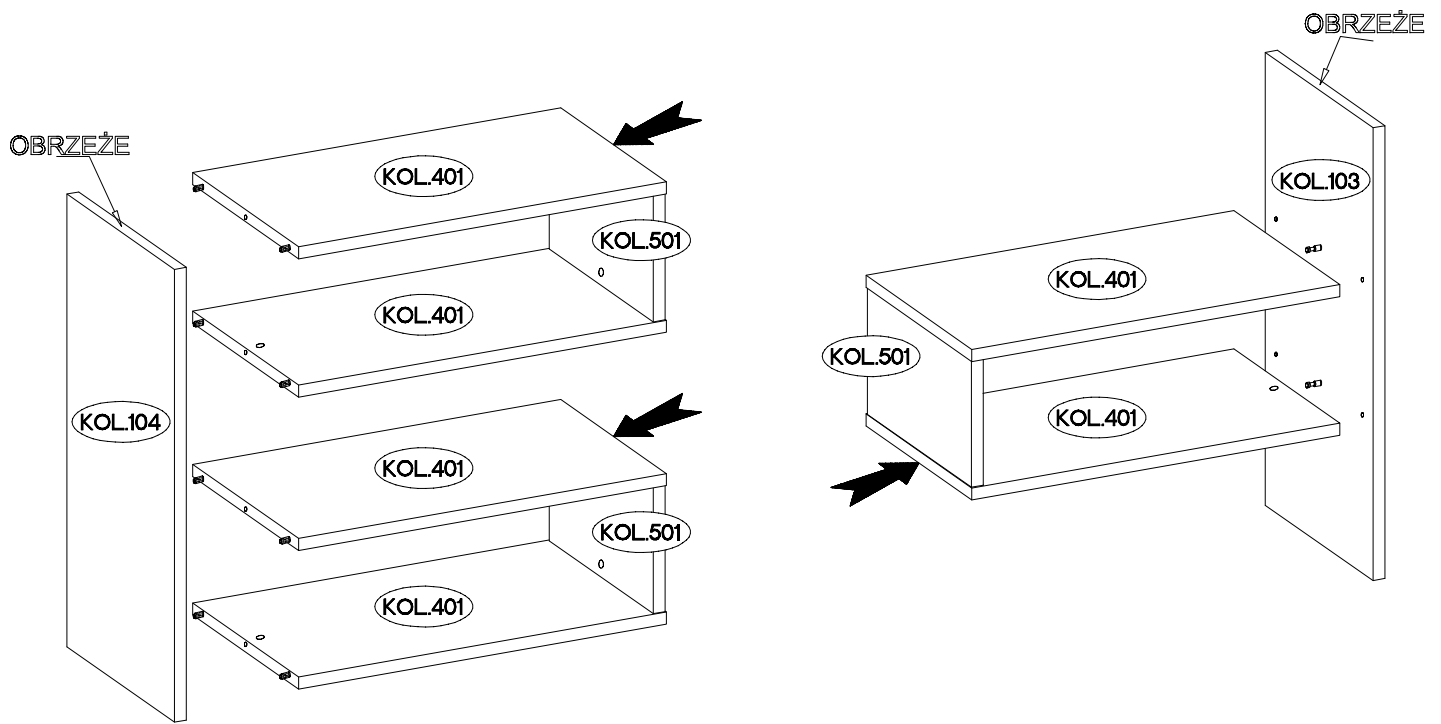

3.

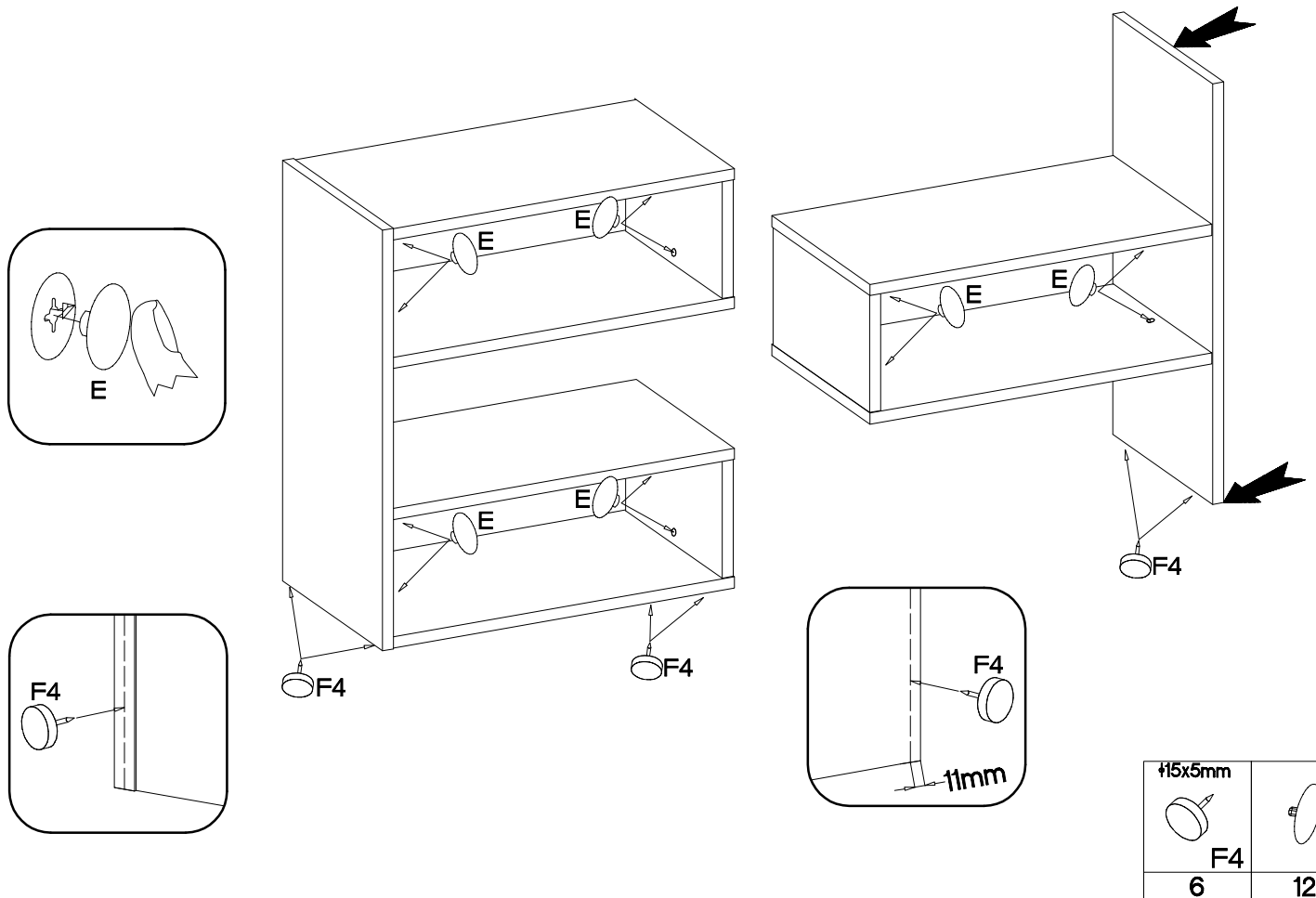

4.



5.

$\pm 5.0 \times 60 \text{mm}$  P12 2	$\pm 10 \times 50 \text{mm}$  O7 2	$\pm 3.5 \times 13 \text{mm}$  L19 2	$\pm 3.5 \times 13 \text{mm}$  P5 4
---	---	---	--

