

JU-10

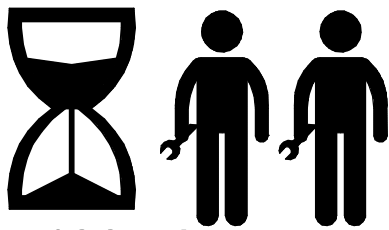

~130 min

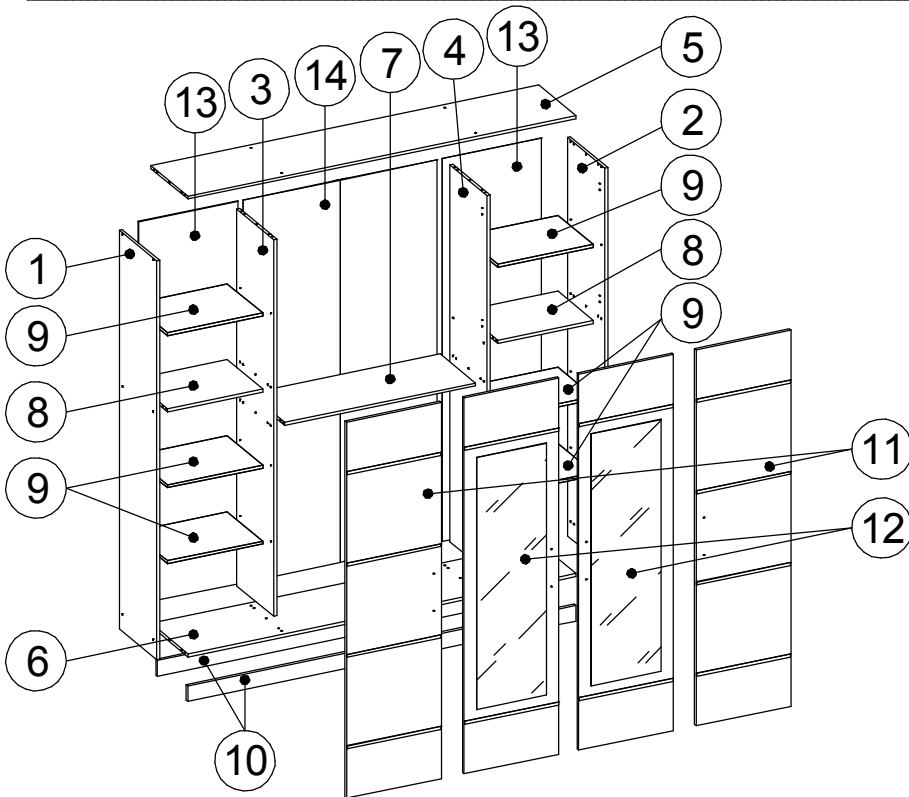
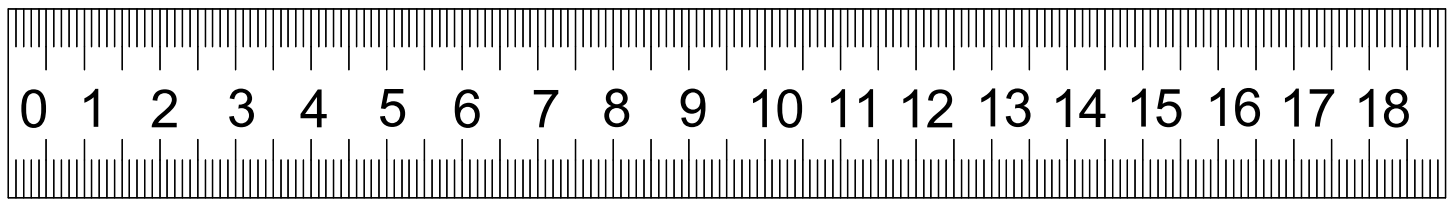
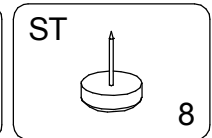
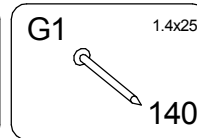
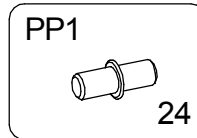
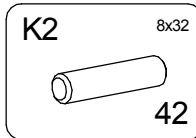
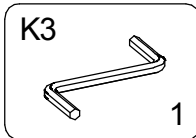
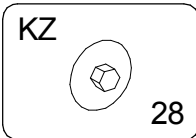
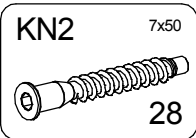
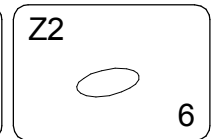
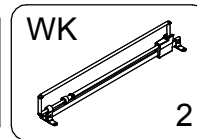
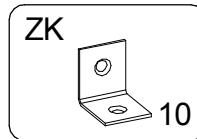
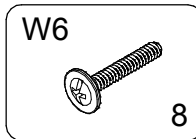
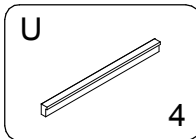
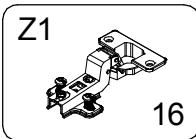
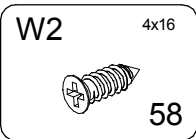
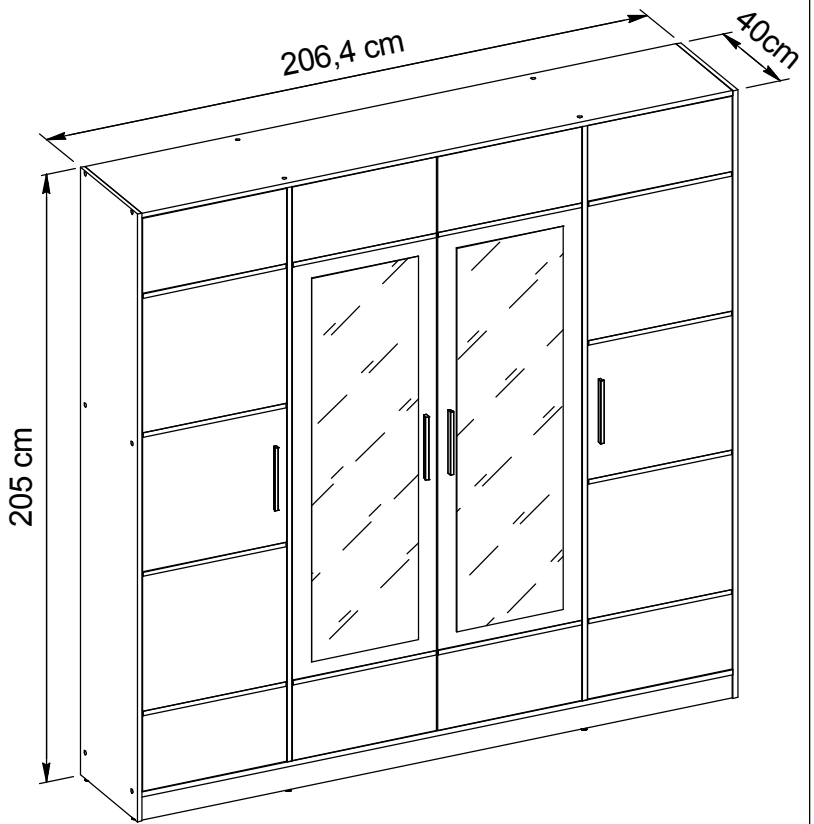
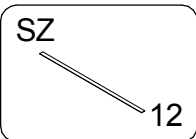
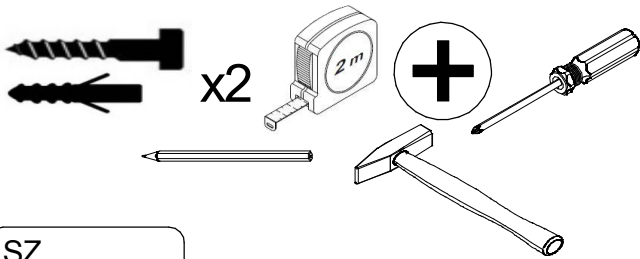

JU-10

1	2050x390x16mm	1
2	2050x390x16mm	1
3	1938x388x16mm	1
4	1938x388x16mm	1
5	2032x389x16mm	1
6	2032x389x16mm	1
7	1000x370x16mm	1
8	500x370x16mm	2
9	500x370x16mm	6
10	2032x80x16mm	2
11	1934x496x16mm	2
12	1934x496x16mm	2
13	1967x520x3mm	2
14	1967x1016x3mm	1

▶ 1

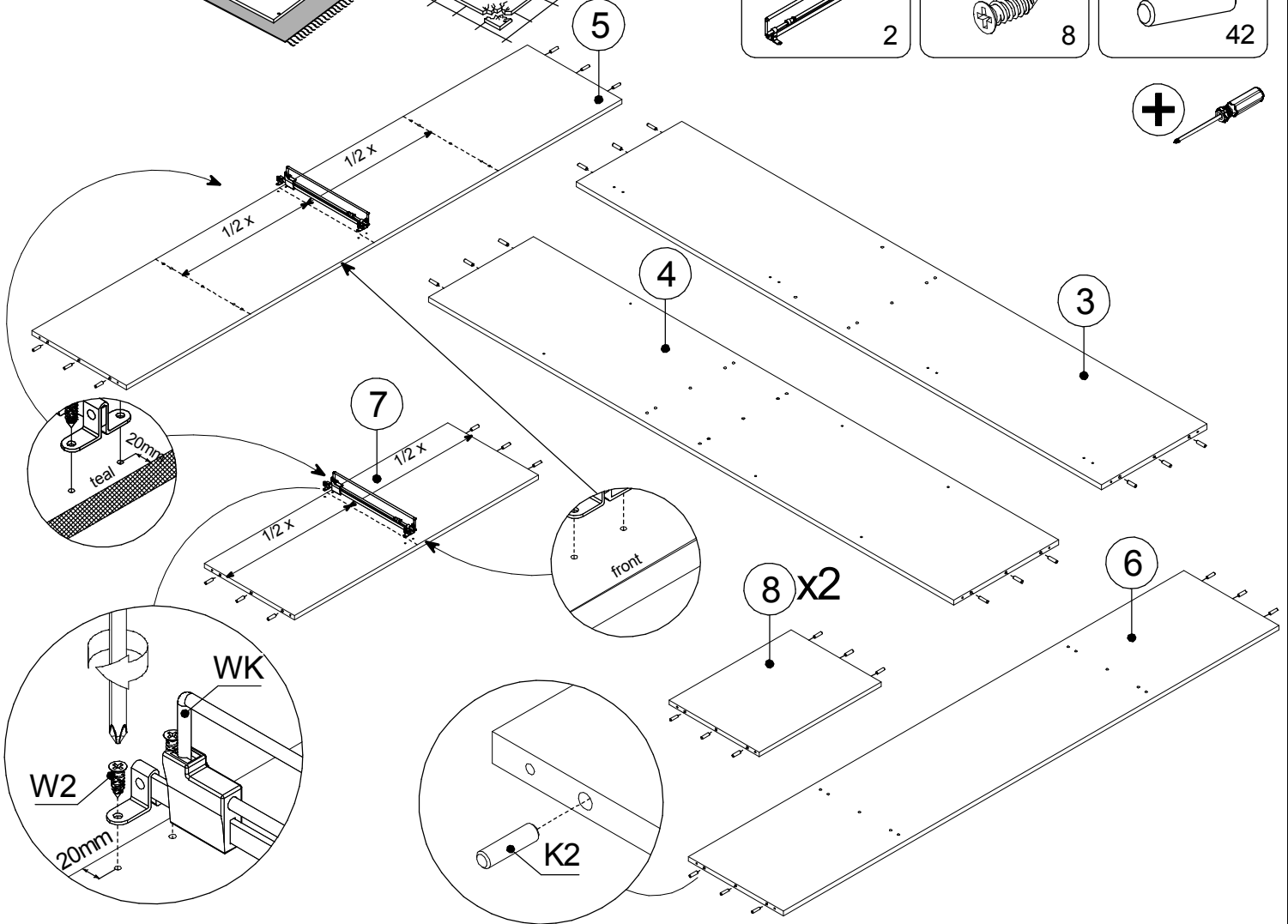
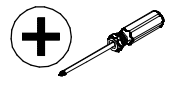
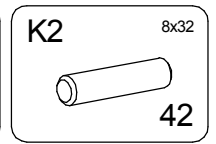
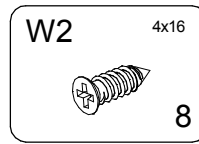
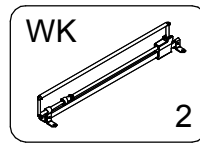
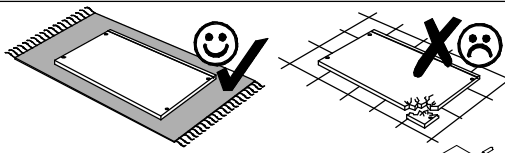

▶ 2

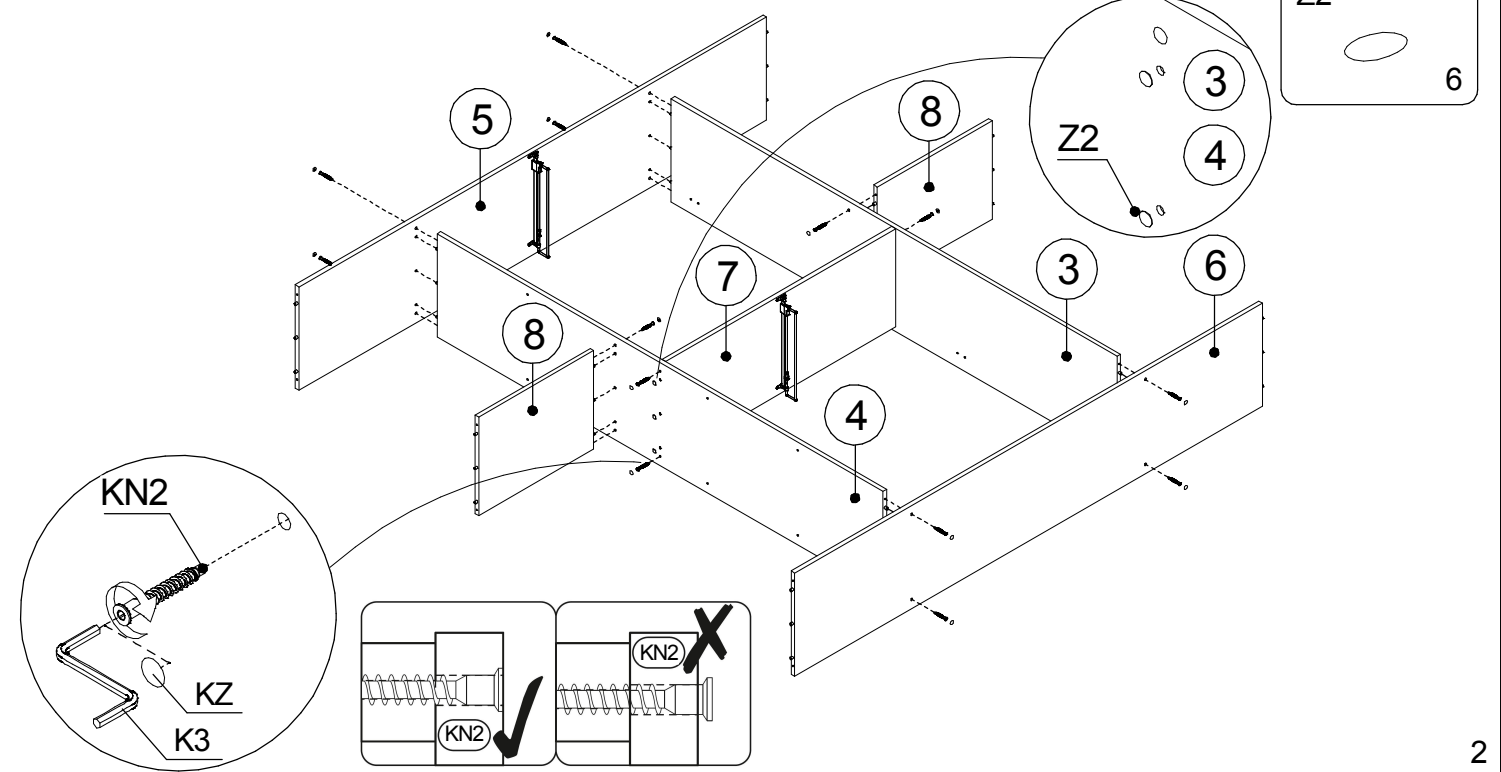
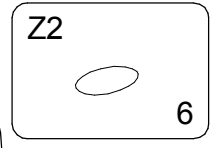
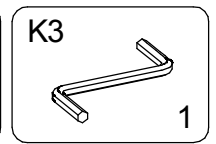
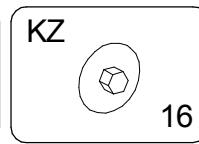
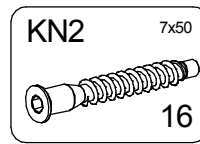
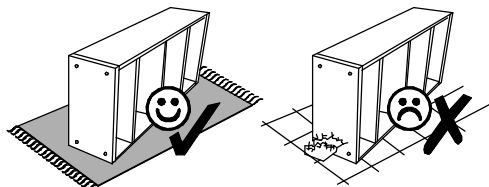

3

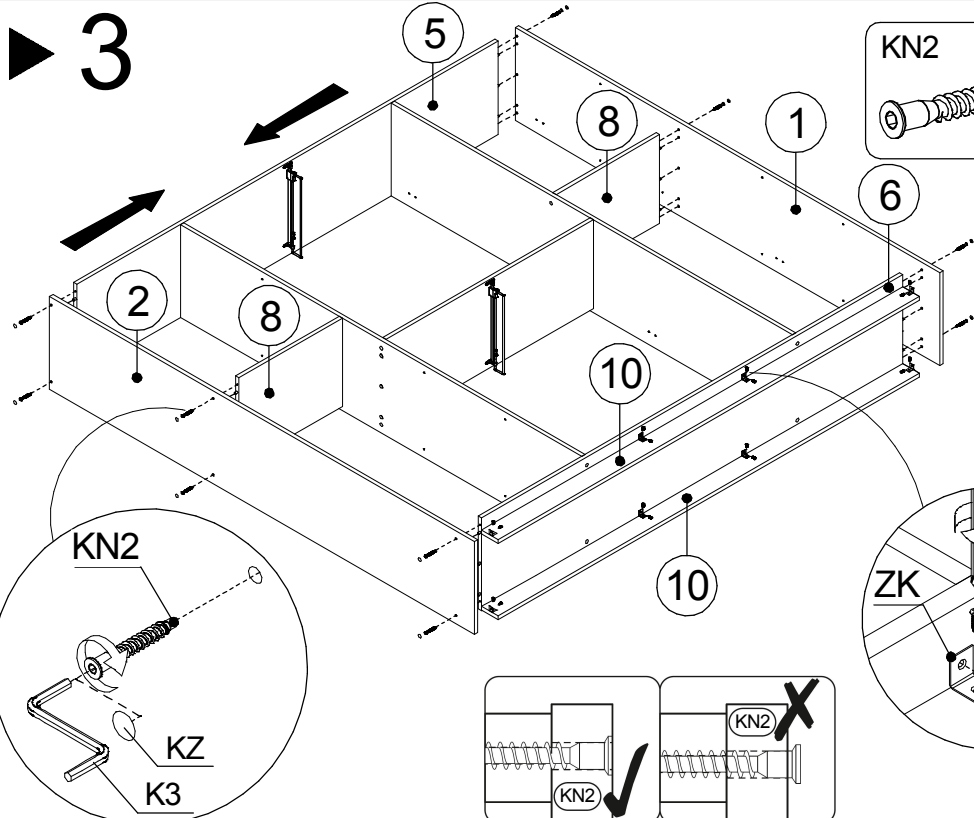

- KN2 7x50 12
 - KZ 12
 - K3 1
 - W2 4x16 16
 - ZK 8
- +

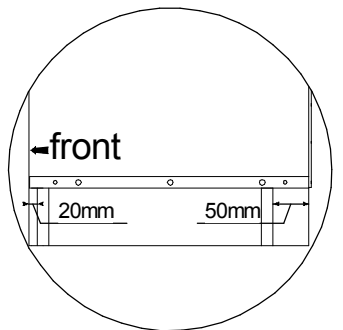
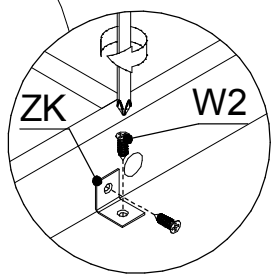
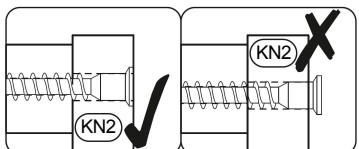
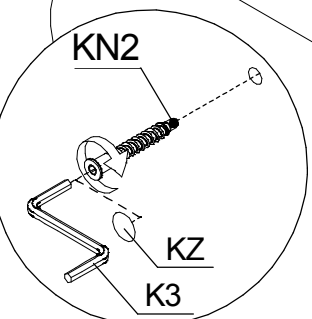

4

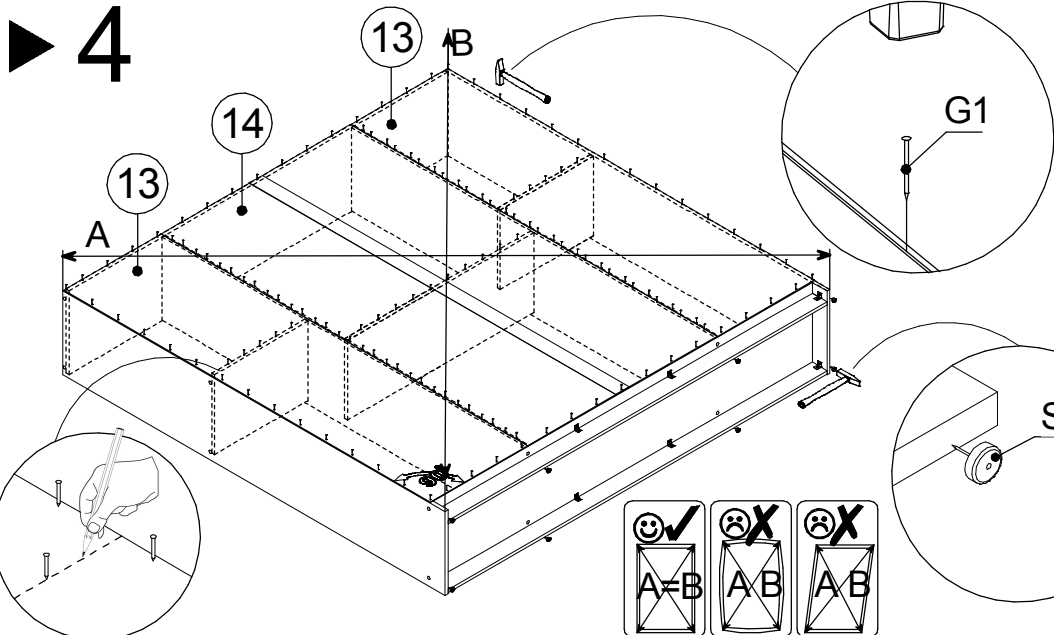

- G1 1.4x25 140
- ST 8

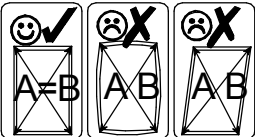
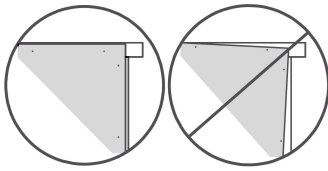
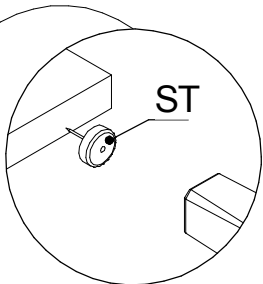
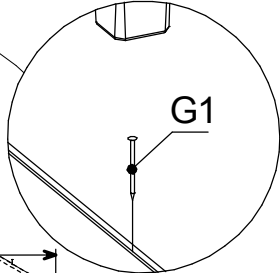
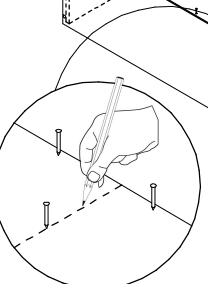

5

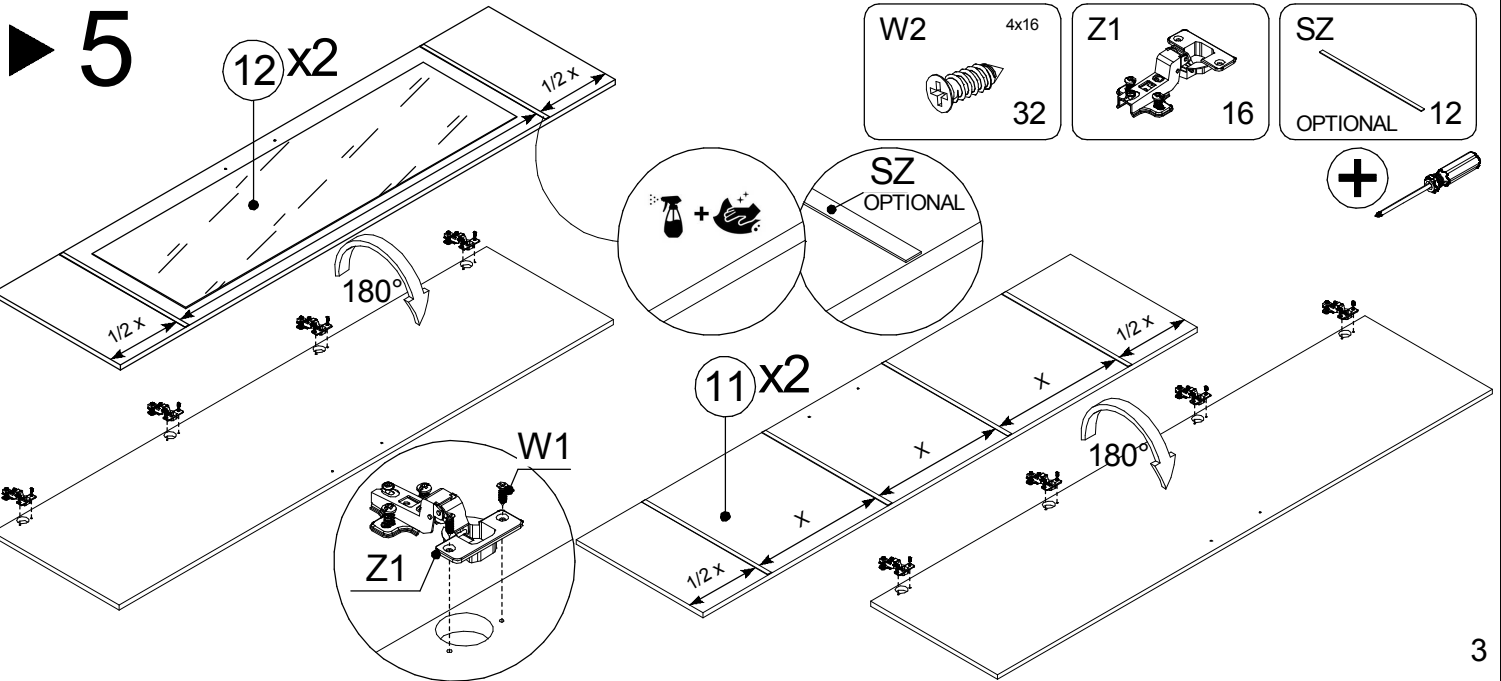

- W2 4x16 32
 - Z1 16
 - SZ OPTIONAL 12
- +

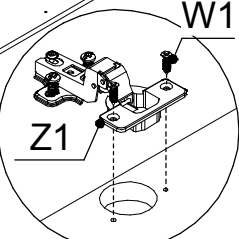
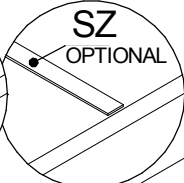
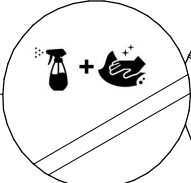

▶ 6

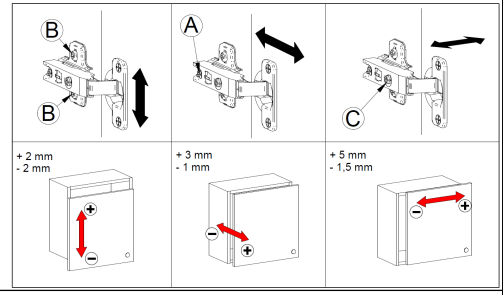
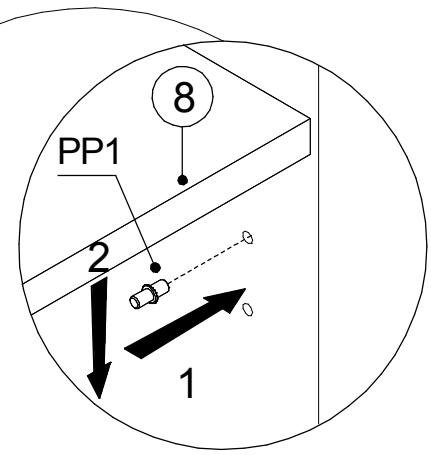
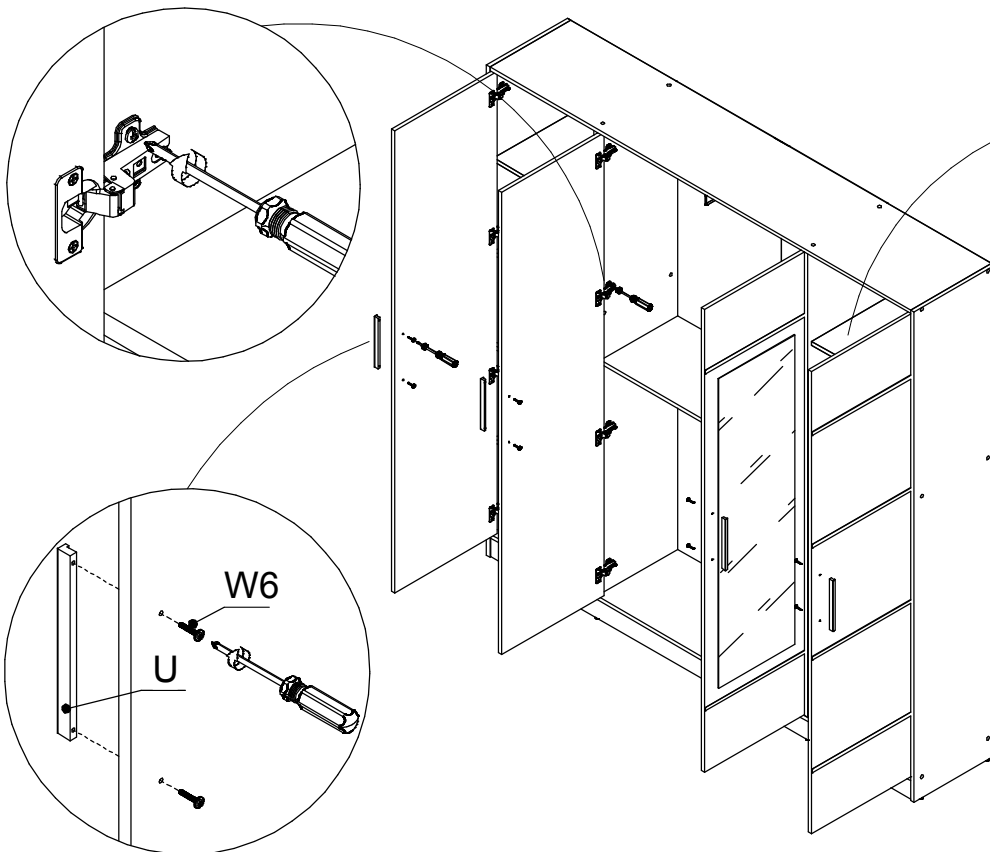
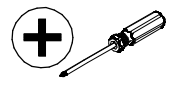
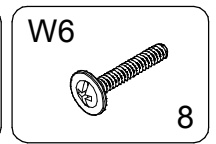
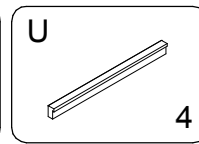
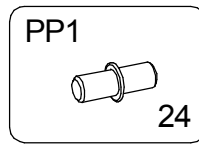

▶ 7

