

MALTA
TYP 113

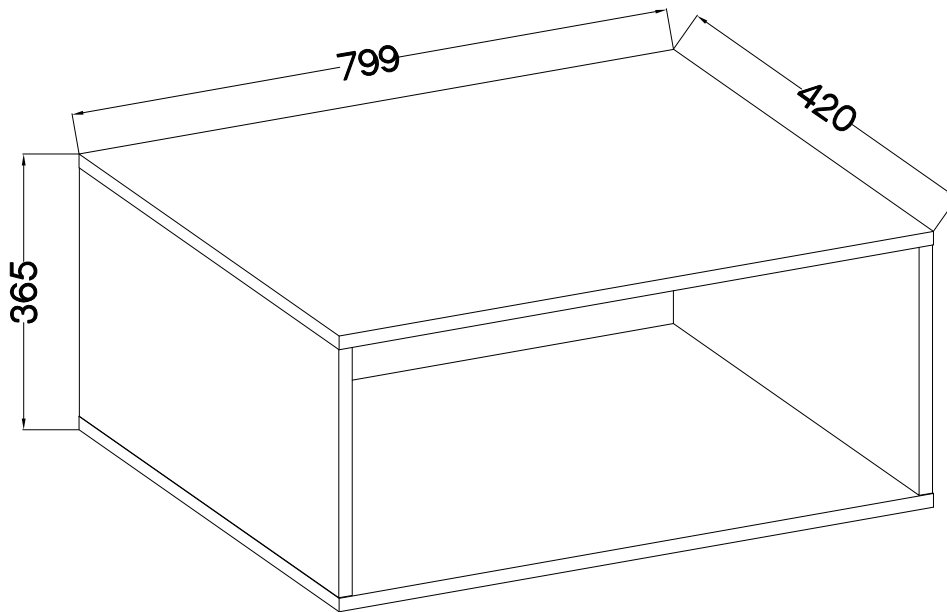
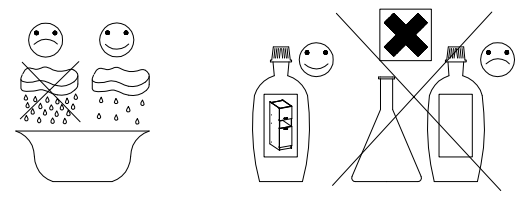

<p>8x30mm A</p>	<p>15/12mm C</p>										
8	8										
<p>L=20mm D2</p>	<p>20 E11</p>	<p>14 E13</p>	<p>L K9</p>	<p>RL K10</p>	<p>L K11</p>	<p>R K12</p>	<p>L</p>	<p>5 M10</p>	<p>6,5/68mm O4</p>	<p>10x50mm O7</p>	
8	8	4	1	1	1	1	6	1	2	2	

ISM-MTA-15

Ersatzteil Nummer	Dimension
MTA.119	329x419x18
MTA.120	329x419x18
MTA.208 x2	799x420x18
MTA.609	338x771x2,5

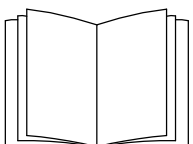
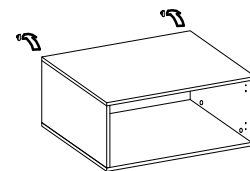
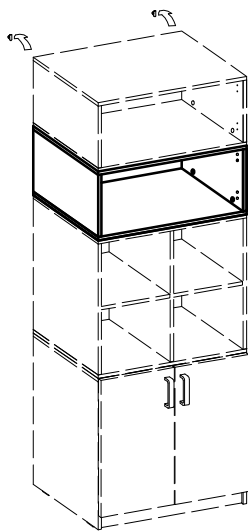
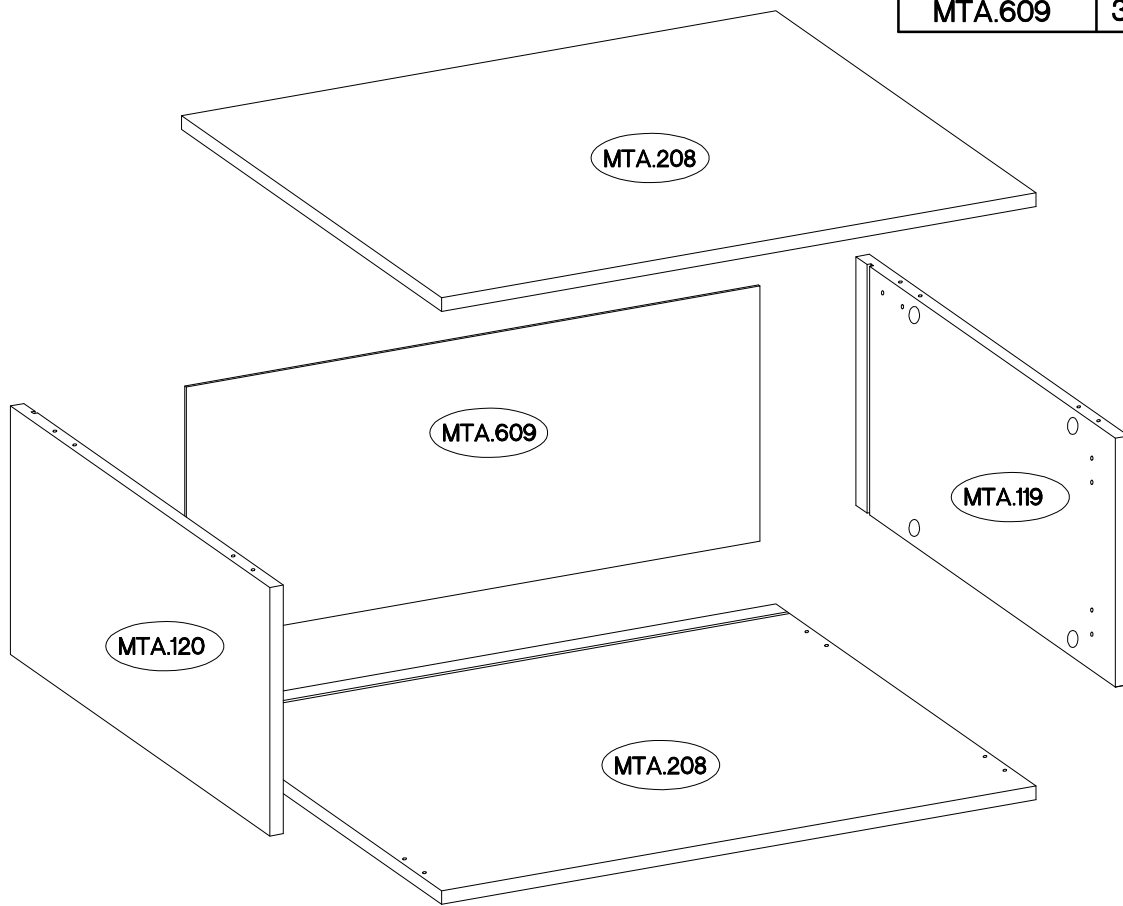

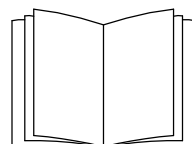

1 — 4



5 — 10

1

$\varnothing 8 \times 30 \text{mm}$ 	L=20mm 	$\varnothing 15/12 \text{mm}$ 
12	D2	C
8	8	8

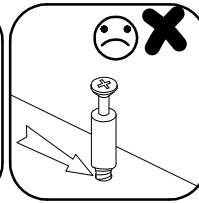
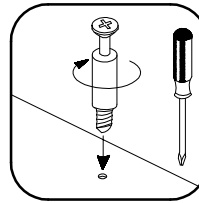
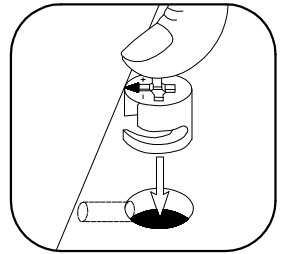
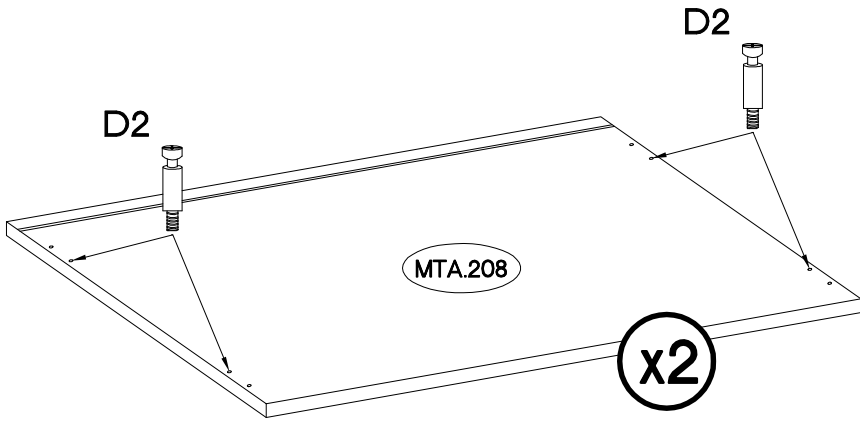
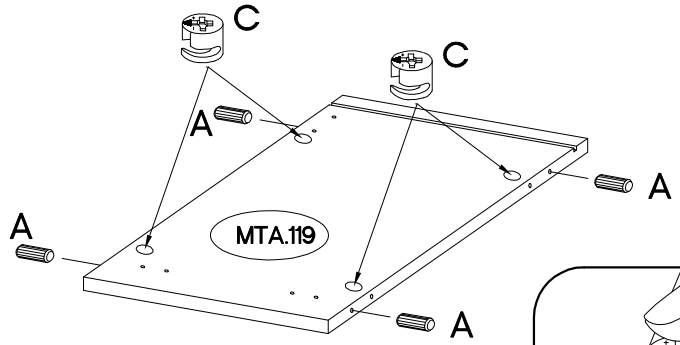
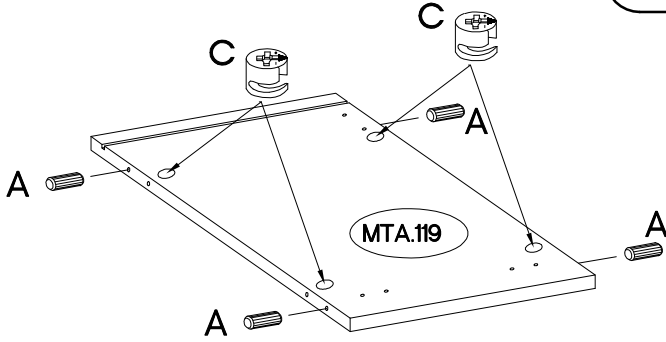
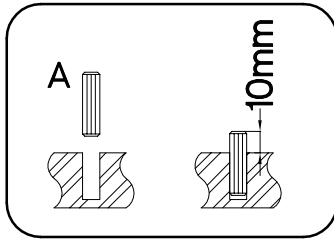
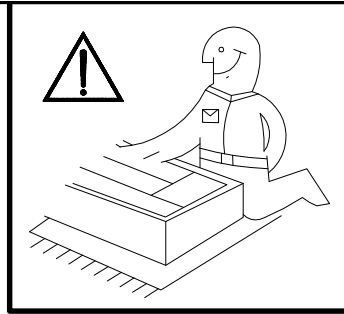

2

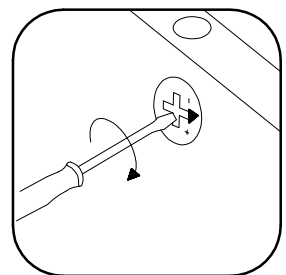
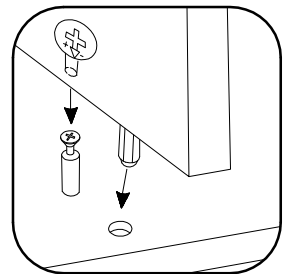
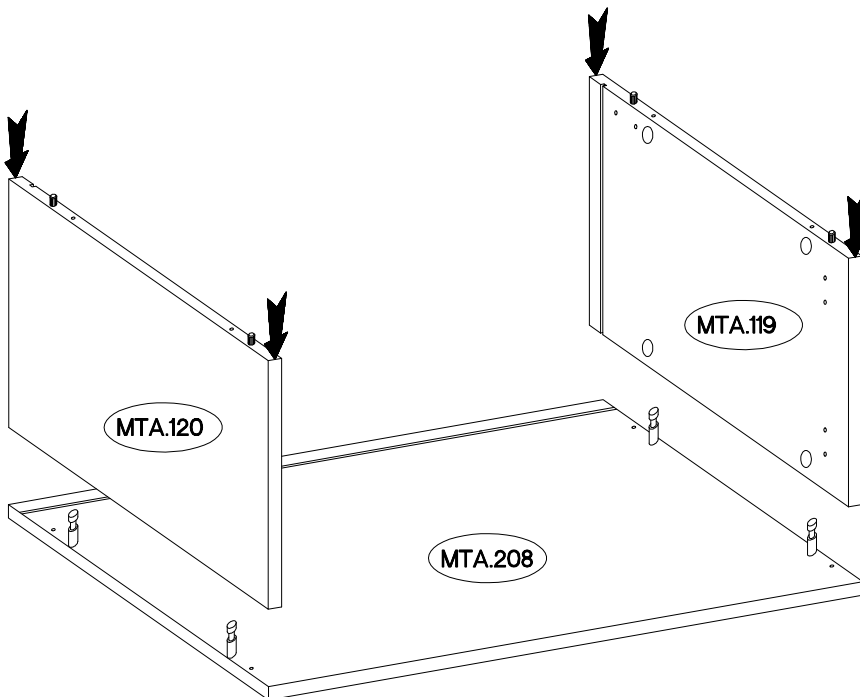



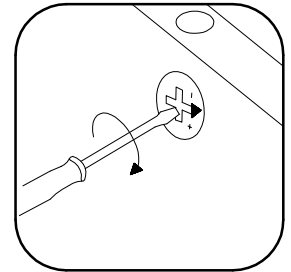
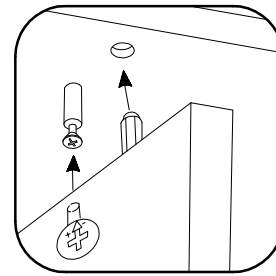
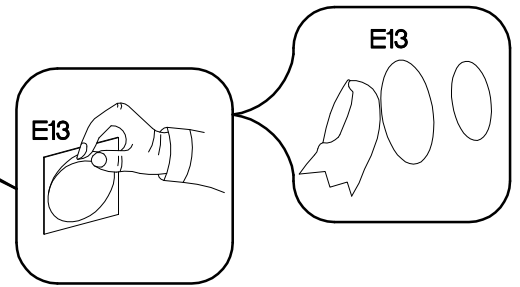
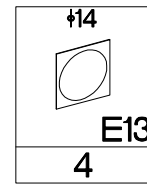
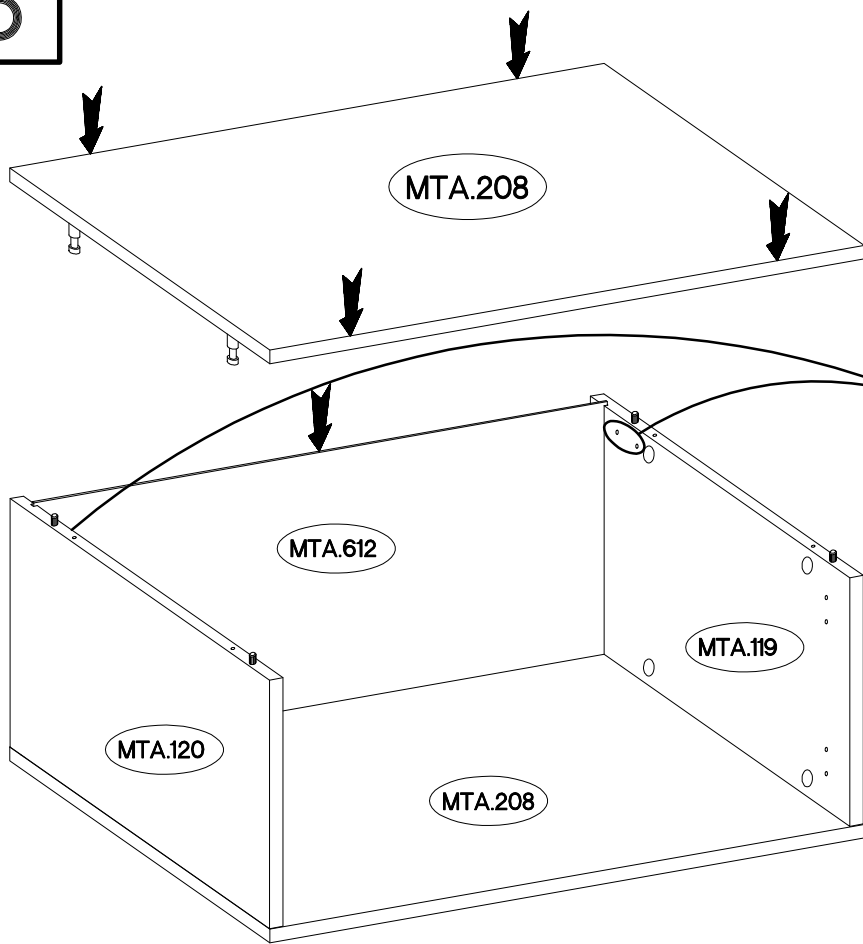

3

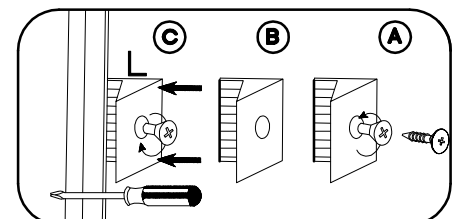
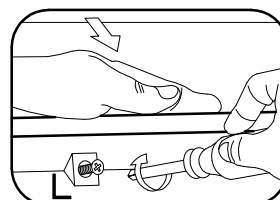
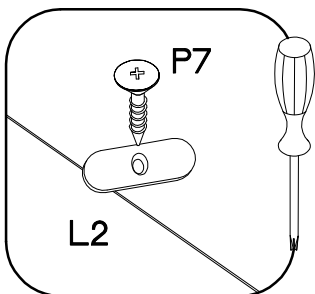
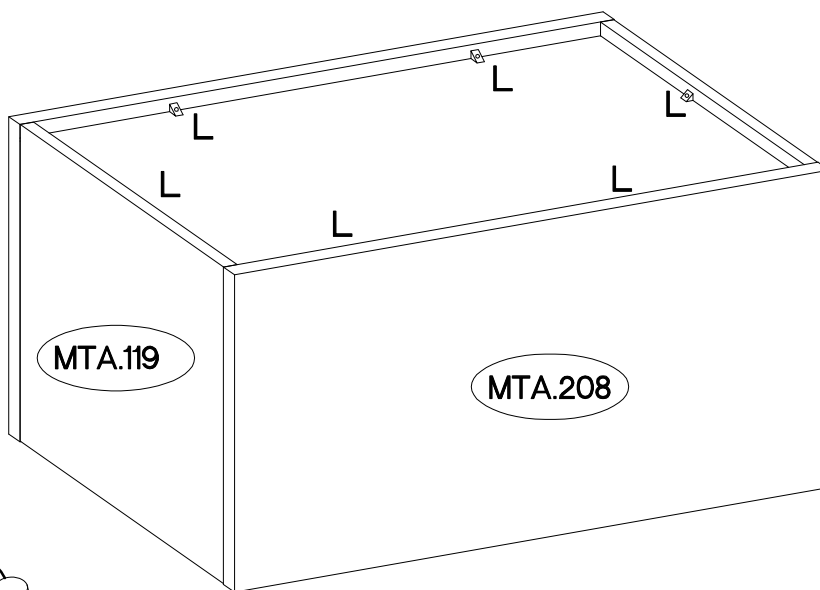
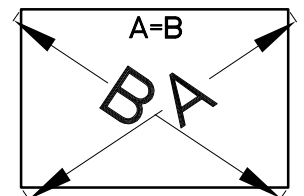
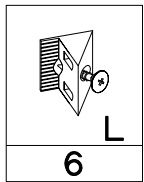

4



5

$\varnothing 8 \times 30 \text{mm}$  12 8	$L=20 \text{mm}$  D2 8	$\varnothing 15/12 \text{mm}$  C 8	L  K9 1	R  K10 1
--	---	---	--	---

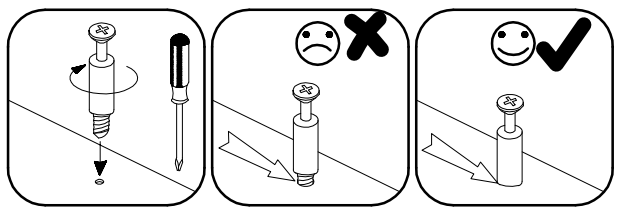
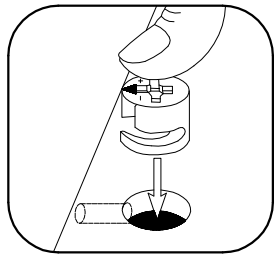
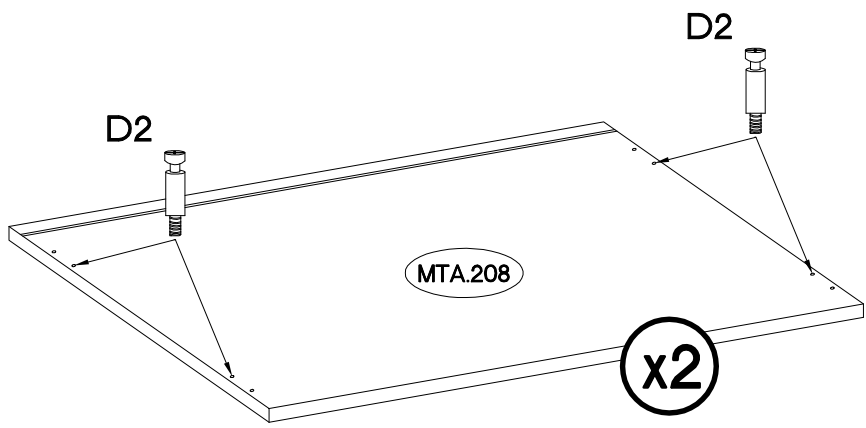
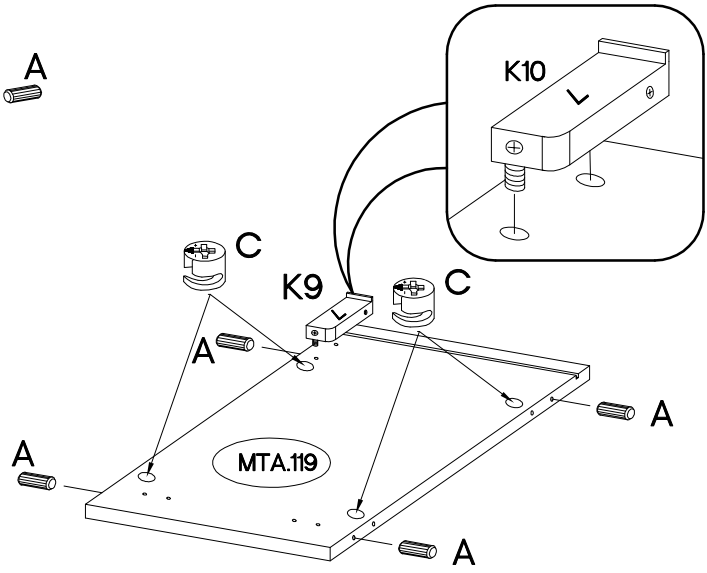
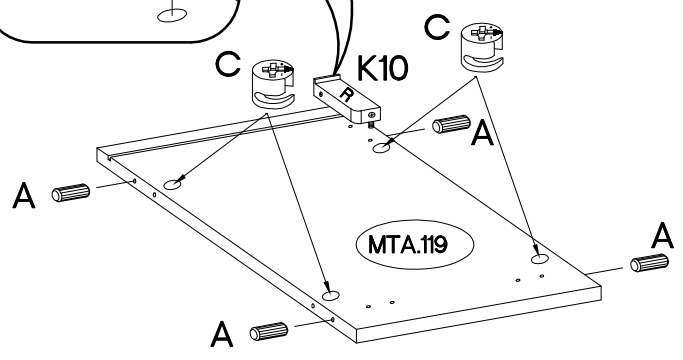
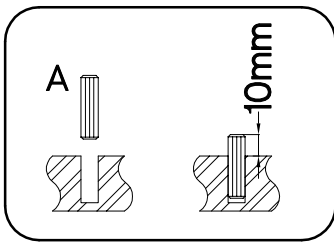
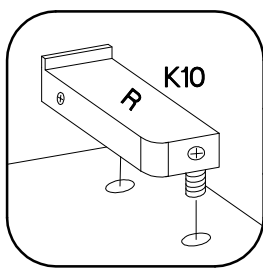
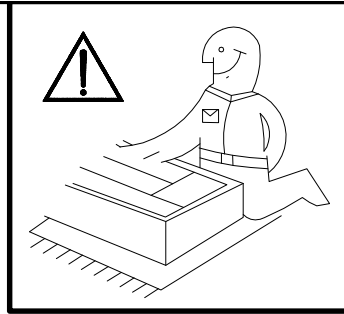

6

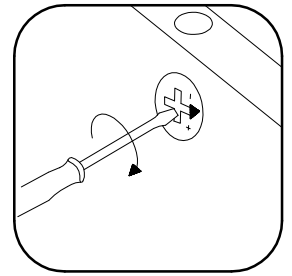
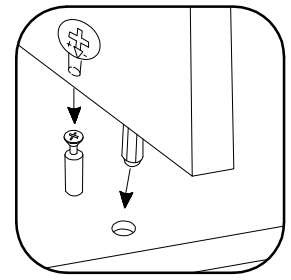
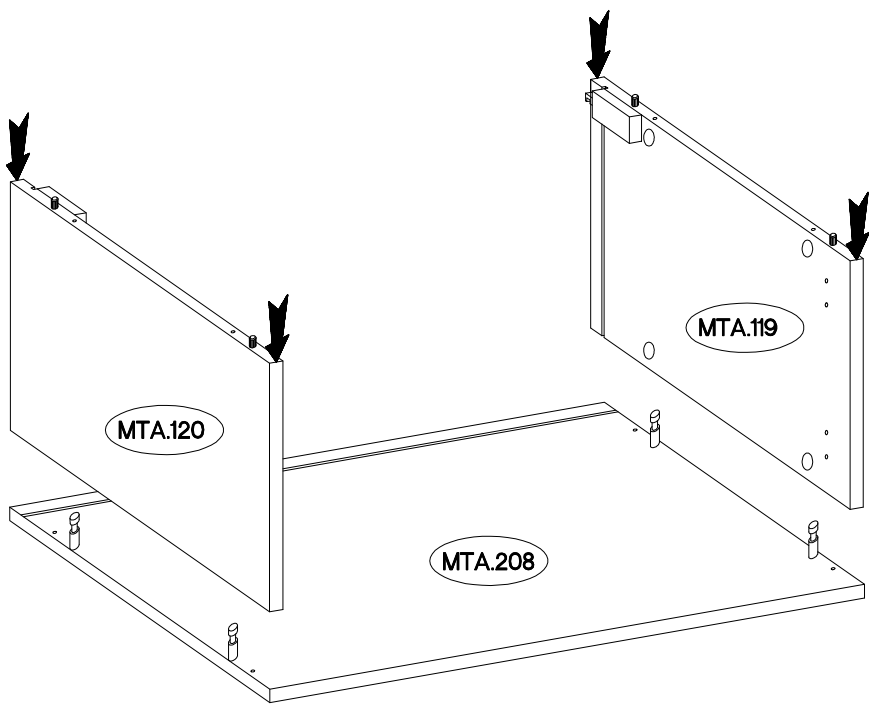

7

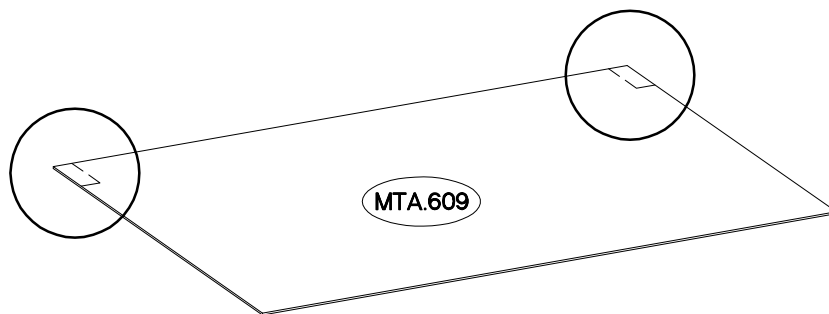
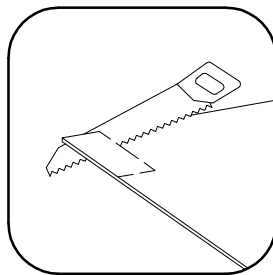
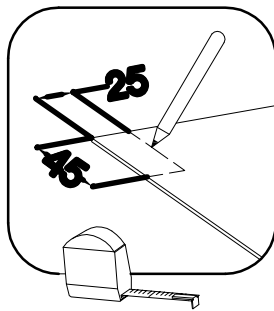



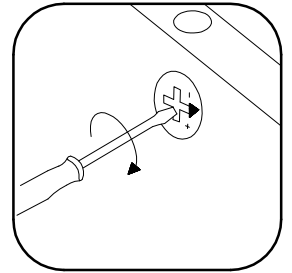
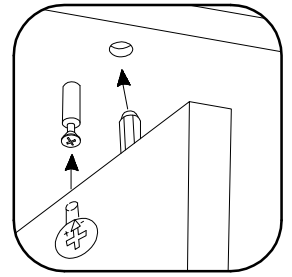
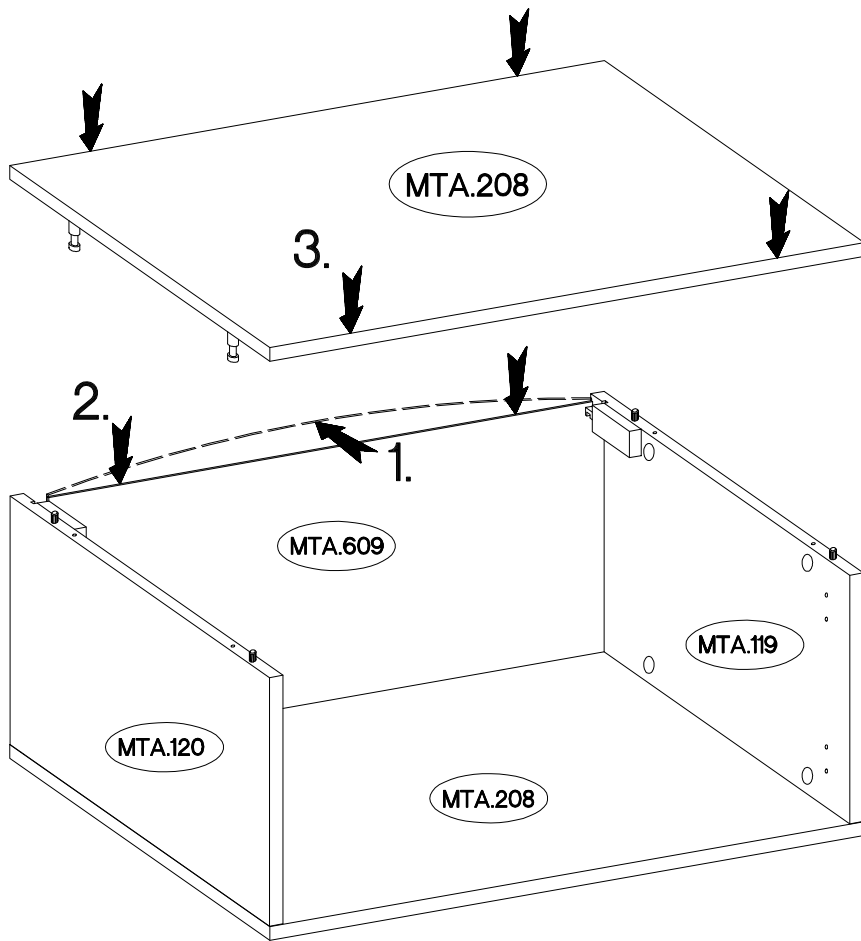

8

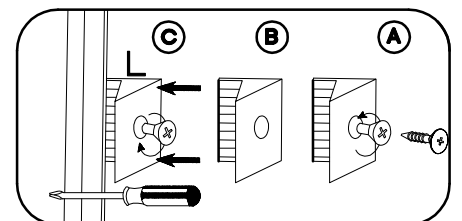
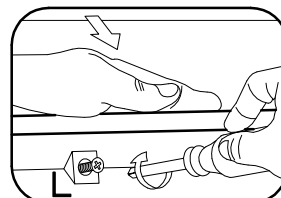
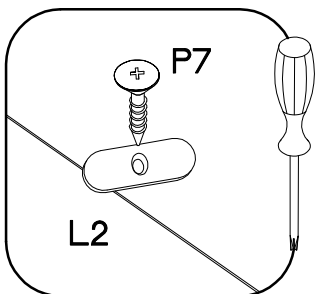
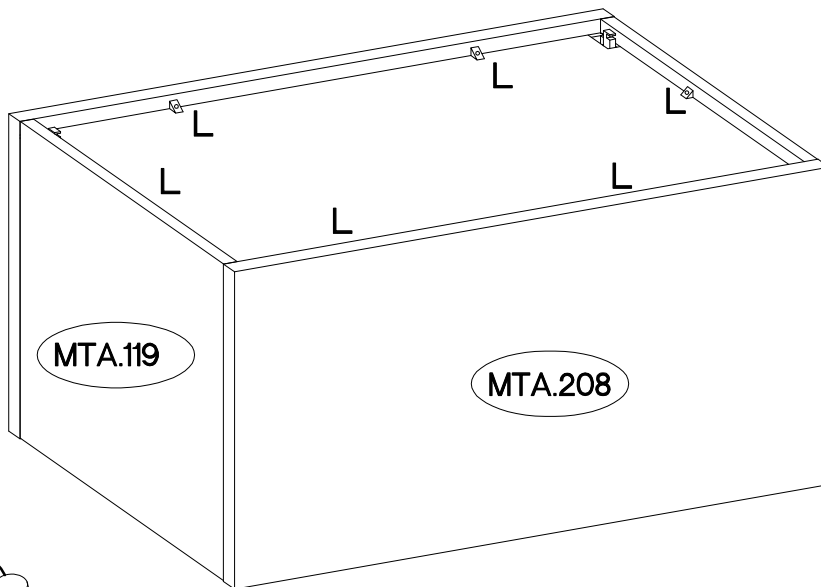
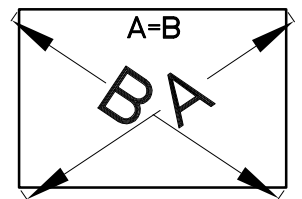
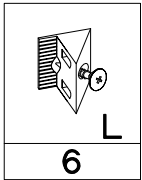

9

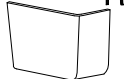

$\varnothing 10 \times 50 \text{mm}$  O7 2	$6,5/68 \text{mm}$  O4 2	L  K11 1	R  K12 1	$\varnothing 20$  E11 8
---	---	---	---	--

