

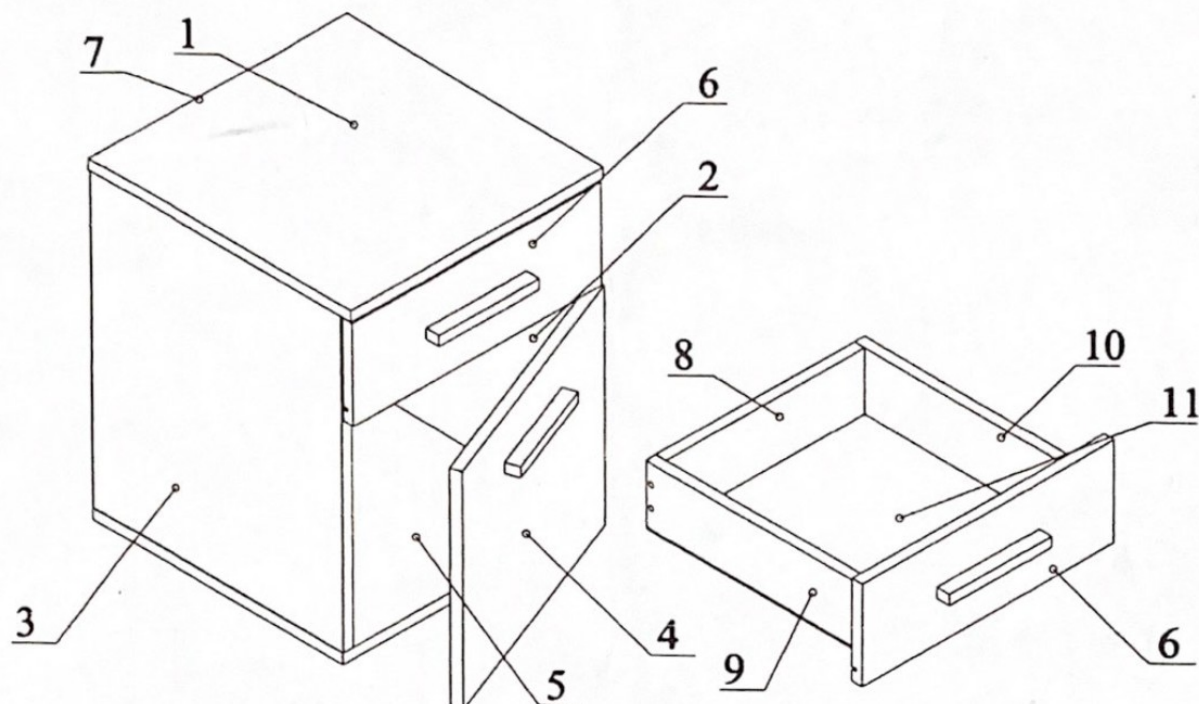















STOLIK NOCNY JULIA

SZER. 40/ WYS. 50,3/ GŁ. 33,5



- JEŚLI W PACZCJE JEST USZKODZONY JAKIKOLWIEK ELEMENT MEBLA, PROSIMY O NATYCHMIASTOWY KONTAKT ZE SPRZEDAJĄCYM LUB PRODUCENTEM. ZMONTOWANIE SZAFY Z WADLIWYM ELEMENTEM SKUTKUJE ODRZUCENIEM REKLAMACJI.
- CZYSZCZENIE NALEŻY WYKONAĆ WYŁACZNIE ZA POMOCĄ SCIERCZKI LUB LEKKO NAWILŻONEGO RĘCZNIKA.
- NIE STOSOWAĆ ŚRODKÓW CZYSZĄCYCH DO SZOROWANIA

K1  X16 Kołek	KN  X 4 Konfirmat	T1  X 2 Trzpień mimośrodowy	M1  X 2 Mimośród	US1  X 6 Wkręt "2,5 x 25"
S1  X 4 Nóżka	US  X 4 Wkręt "16"	PO  Prowadnica prawa / lewa	PO  Prowadnica prawa / lewa	UK  X 2 Rączka
UP3  X 4 Wkręt	G  X 20 Gwóźdki	PR  X 1 Zawias	Z1  X 1 Zawias	KI  x1 Klucz imbusowy
US4  X 8 Wkręt "40" (do nóżek)				

