









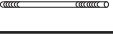

ASSEMBLY INSTRUCTION

Item NO: LCT459

HARDWARE LIST			
NO.	PART	DESCRIPTION	Q'TY
A			1
B			1
C			2
D			4
E			4
F			4
G			4
H			4
I			1
J			4
K			4

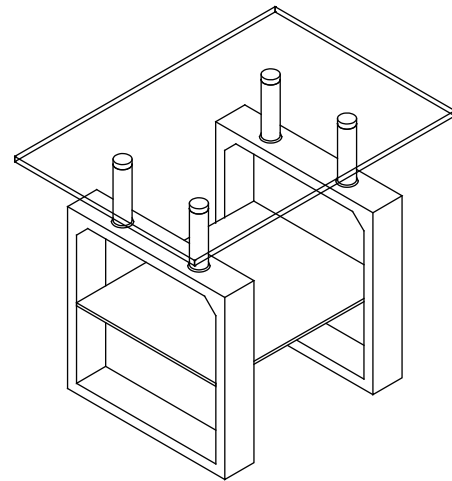

step 1

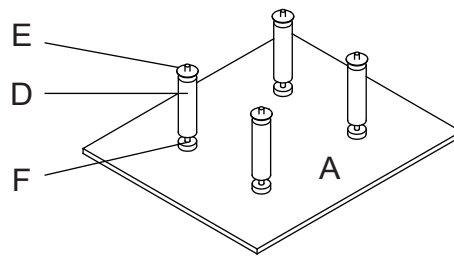

step 2

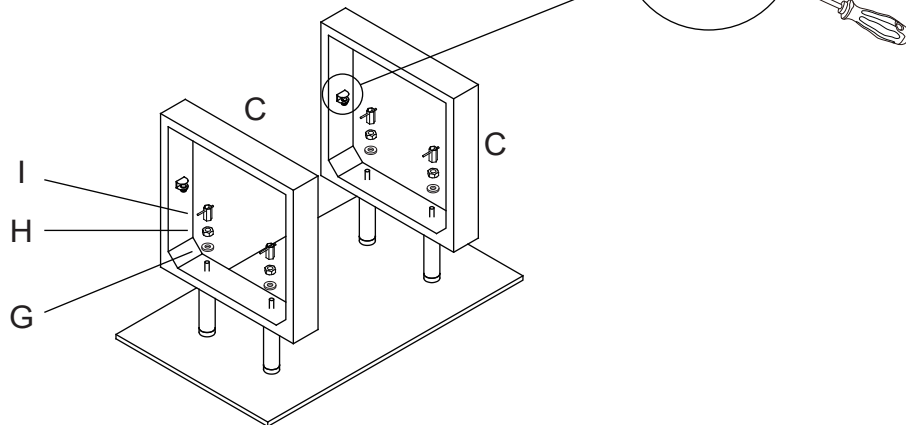

step 3

