

OPTIMAL 14

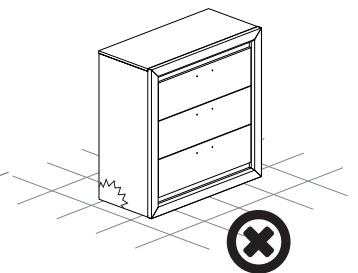

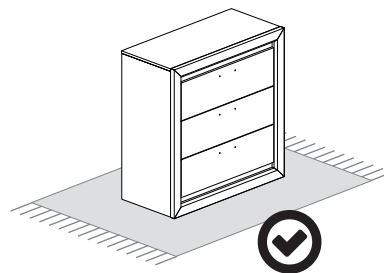

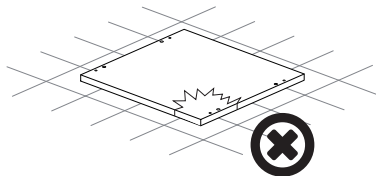

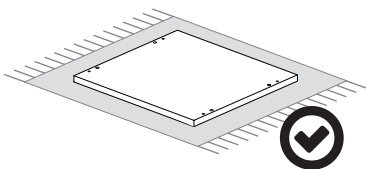
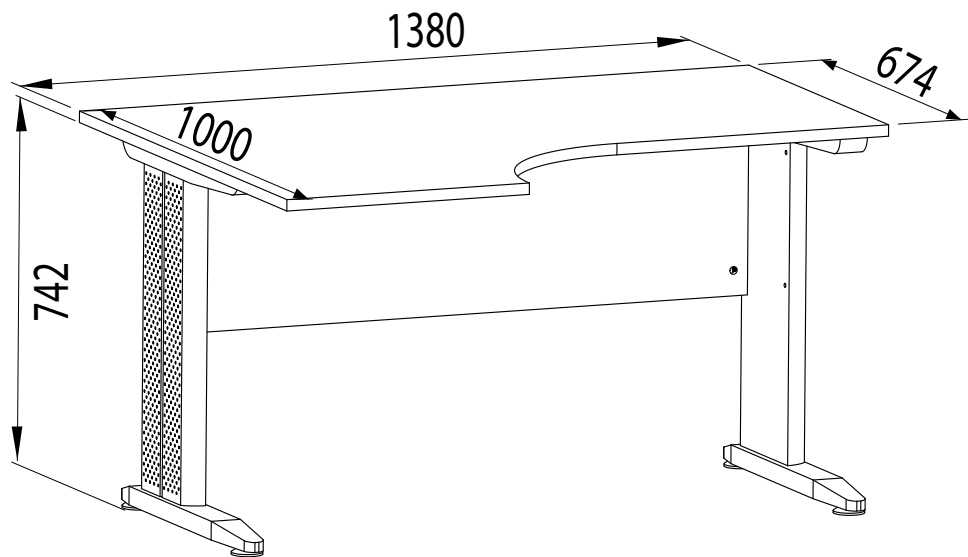
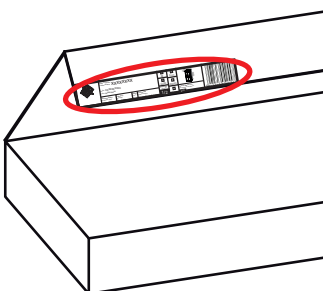

PL - Zachowaj w razie reklamacji !!! / BG - Пазете в случай на рекламация !!! / CZ - Uchovávejte pro případ stížnosti !!! / DE - Bewahren Sie das Etikett für Reklamationen !!! / ENG - Keep the label for complaints !!! / ES - Conservar en caso de reclamación !!! / EST - Kaebuse korral hoidke alles !!! / FR - Conserver en cas de réclamation !!! / HR - Zadržite u slučaju prigovora !!! / HU - Tartsa fenn panasz esetén !!! / IT - Conservare in caso di reclamo !!! / LT - Laikykite skundo atveju !!! / LV - Saglabājiēt sūdzības gadījumā !!! / NL - Bewaren in geval van een klacht !!! / PO - Guardar em caso de reclamação !!! / RO - Păstrați în cazul unei reclamații !!! / RU - Сохранить в случае рекламации !!! / S - Föörvara vid klagomål !!! / SK - Majte v prípade reklamácie !!! / SLO - Hranite v primeru pritožbe !!! / SRB - Задржите у случају жалбе !!! / TR - Şikayet durumunda saklayın !!! / UKR - Зберігати у разі скарги !!!

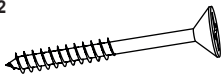
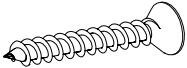

Nazwa wyrobu: Product Name: XXXXXXXXXX			
Kolor: XXXXXXXXXX Color: XXXXXXXXXX			
Data produkcji: Production date:	Pakujący: Packager:	Szkló: Glass:	Kod paczki: Code packages:
0000-00-00	xx0/xx0	0	0xxxxx00-000-0/0

OPTIMAL 14

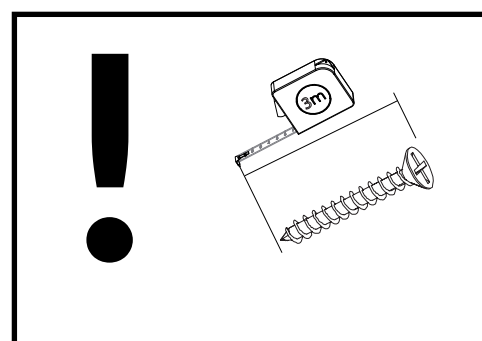

<p>WT33 x 2 5x55</p> 	<p>WT32 x 2 5x40</p> 	<p>ZS2 x 4</p> 
<p>ZM6 x 4</p> 	<p>B2 x 4</p> 	<p>x 1</p> 

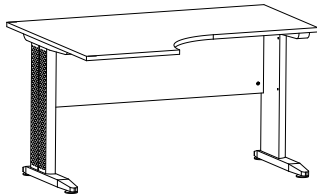

OPTIMAL 14

SZ.01.2017



	CODE			
①	OPTIMAL14_01	1380	1000	1
②	OPTIMAL14_02	1200	334	1
③				
④				
⑤				
⑥				

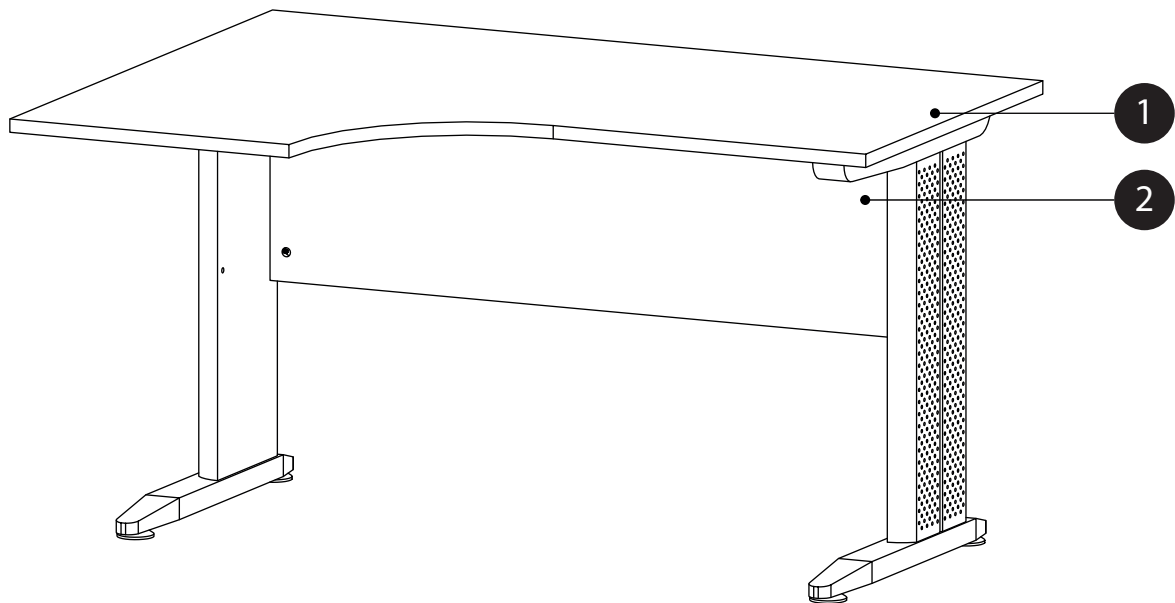

A ▶

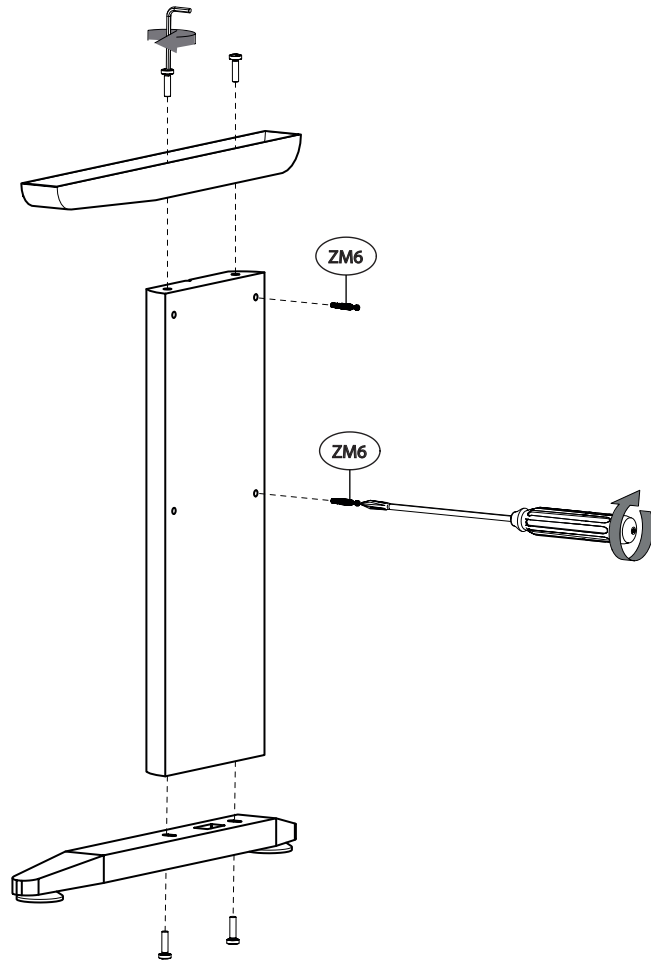

B ▶

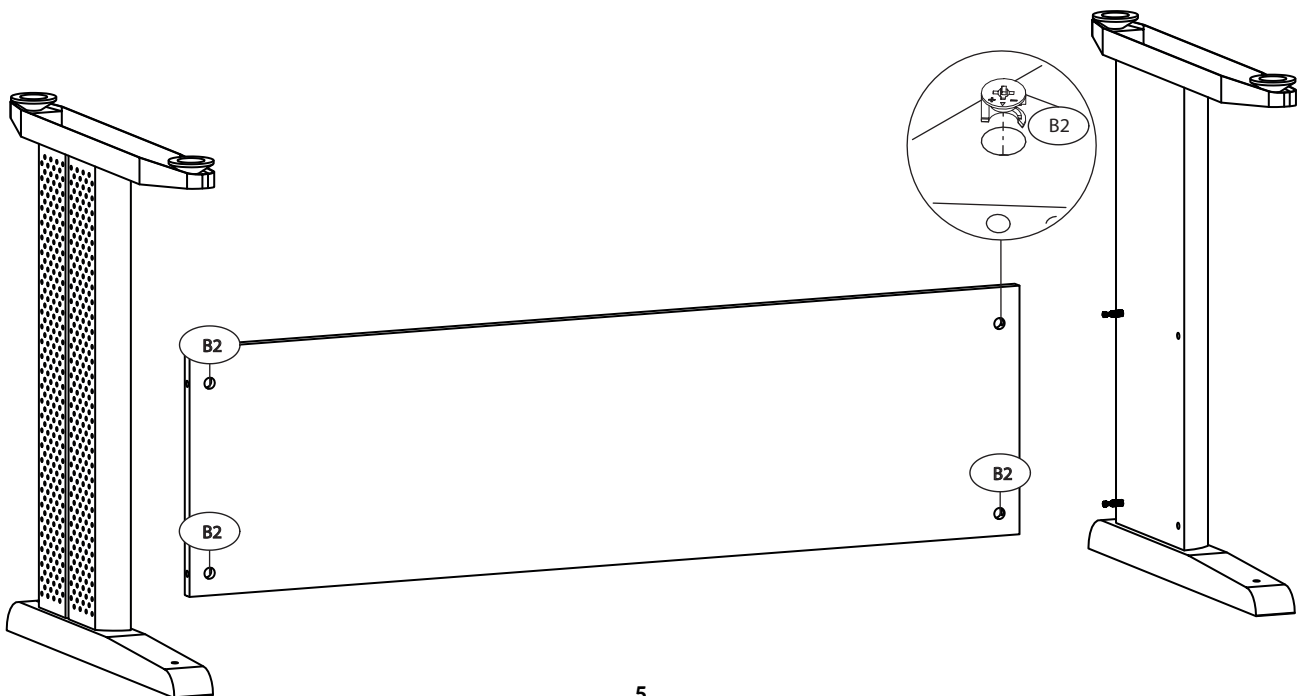
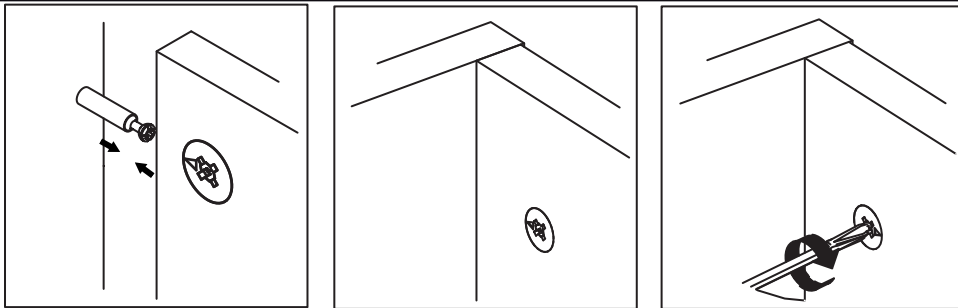

C ▶

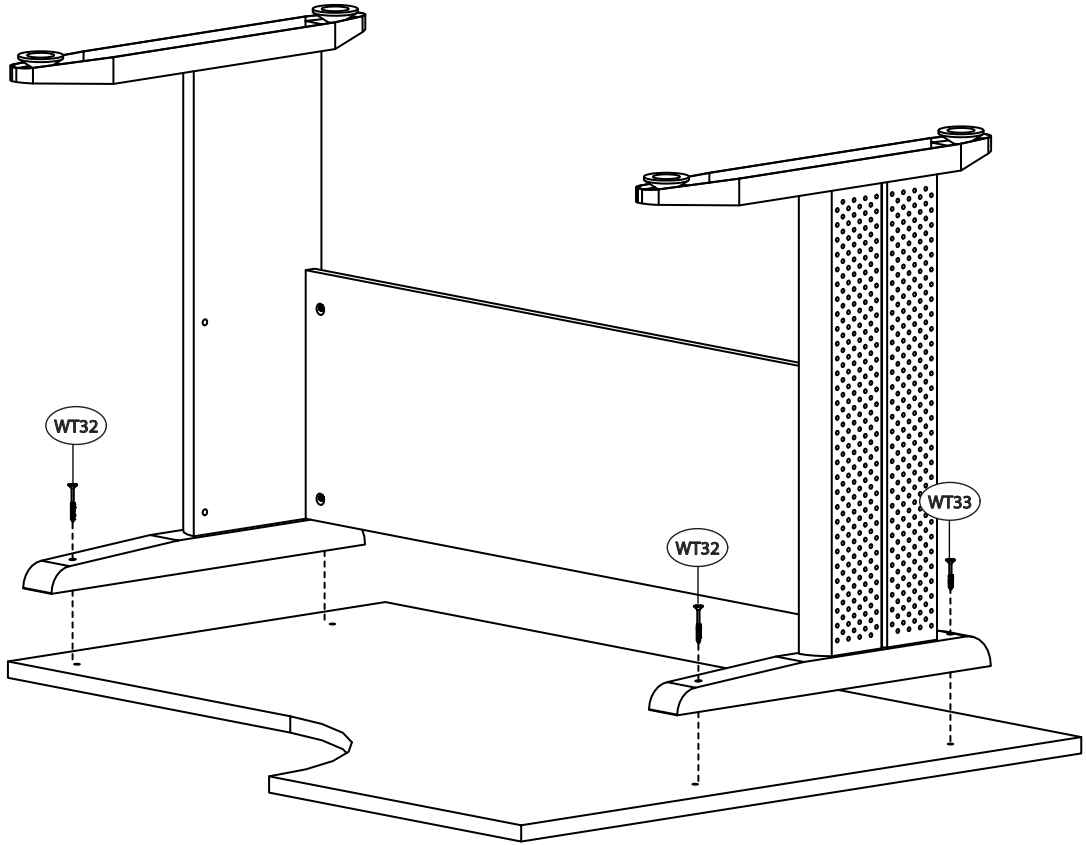

D ▶

