

# DALLAS 7

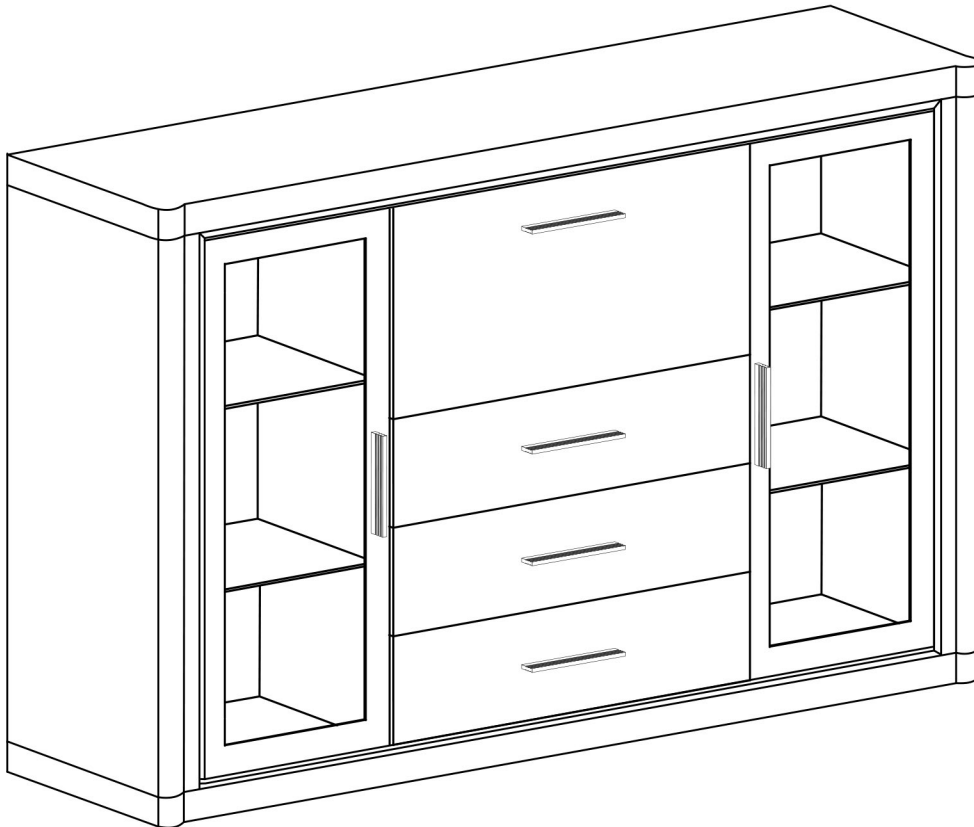

Nr	D[mm]	S[mm]	G[mm]	
1	1570	450	48	1
2	1570	450	48	1
3	1530	25	16	2
4	995	422	16	1
5	995	422	16	1
6	995	100	32	1
7	995	100	32	1
8	1026	405	16	1
9	1026	405	16	1
10	438	380	4	4
11	636	386	16	1
12	636	190	16	3
13	400	150	16	3
14	400	150	16	3
15	560	150	16	3
16	590	405	2,5	3
17	1050	462	2,5	2
18	1050	634	2,5	1
19	618	405	16	1
20	966	365	16	2

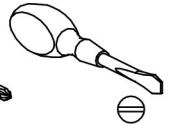
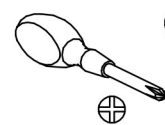
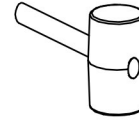
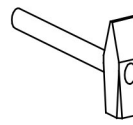
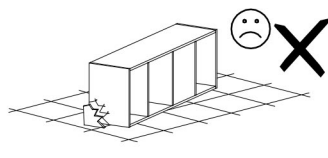
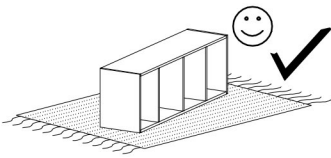
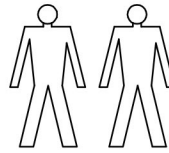

**X2 - 4 St.**



**X1 - 28 St.**

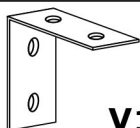

**V1 - 1 St.**

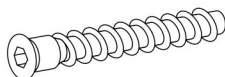

**W - 4 St.**



**Y - 12 St.**

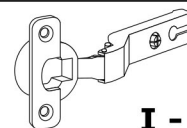

**I - 2 St.**

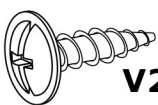

**V2 - 2 St.**  
3,5x16 mm

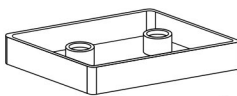

**A - 6 St.**

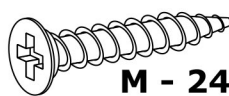

**M - 24 St.**  
3,9x25 mm

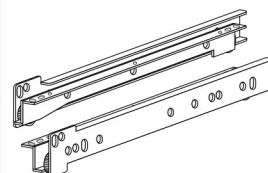

**T - 3 Kpl.**

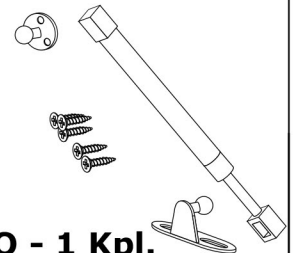

**Q - 1 Kpl.**



**P - 16 St.**

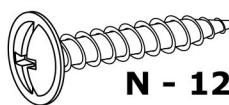

**N - 12 St.**  
4x27 mm

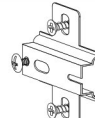

**C - 6 St.**



**U - 6 St.**

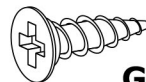

**G - 24 St.**  
3,5x16 mm

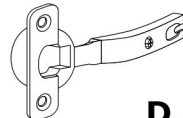

**D - 4 St.**

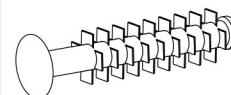

**F - 12 St.**

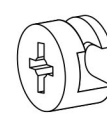

**L - 28 St.**



**E - 110 St.**

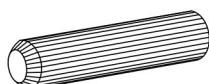

**B - 28 St.**

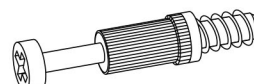

**K - 28 St.**



**Z - 1 St.**

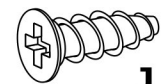

**J - 12 St.**  
5x13 mm

# DALLAS 5

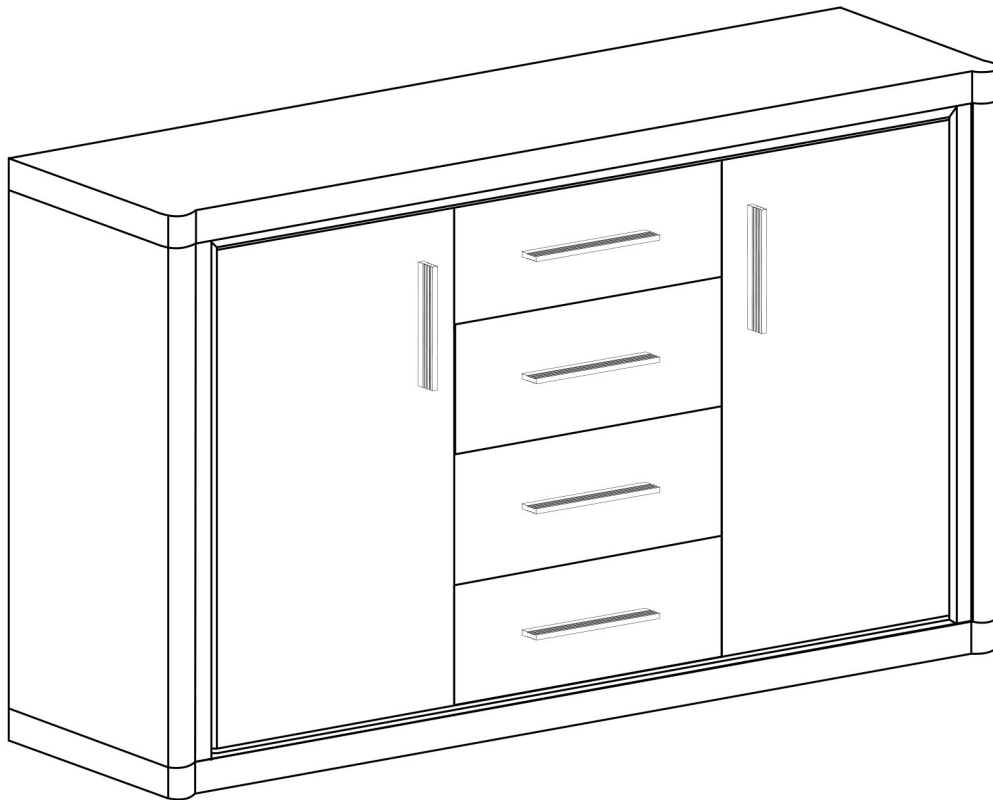
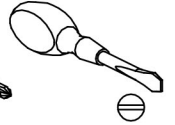
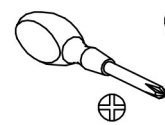
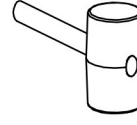
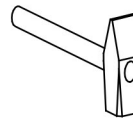
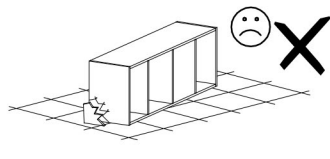
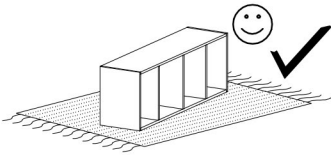
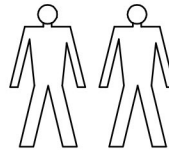

Nr	D[mm]	S[mm]	G[mm]	
1	1370	450	48	1
2	1370	450	48	1
3	1330	25	16	2
4	800	422	16	1
5	800	422	16	1
6	800	100	32	1
7	800	100	32	1
8	833	405	16	1
9	833	405	16	1
10	440	380	16	2
11	1360	856	2,5	1
12	435	190	16	4
13	400	150	16	4
14	400	150	16	4
15	360	150	16	4
16	390	405	2,5	4
17	772	365	16	1
18	772	365	16	1

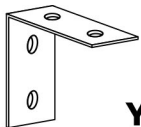

**Y - 1 St.**

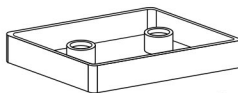

**A - 6 St.**

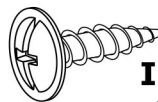

**I - 2 St.**  
3,5x16 mm

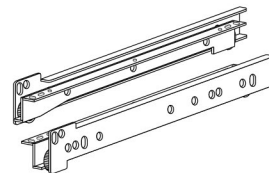

**T - 4 Kpl.**



**X1 - 30 St.**

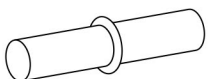

**P - 8 St.**

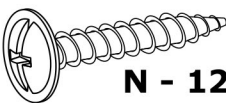

**N - 12 St.**  
4x27 mm

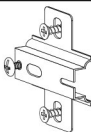

**C - 4 St.**

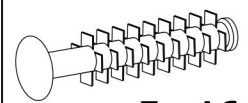

**F - 16 St.**

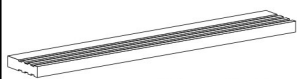

**U - 6 St.**

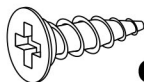

**G - 8 St.**  
3,5x16 mm

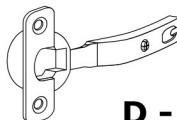

**D - 4 St.**

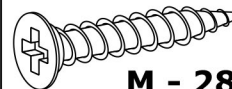

**M - 28 St.**  
3,9x25 mm



**L - 30 St.**



**E - 90 St.**

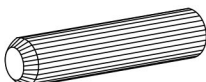

**B - 32 St.**

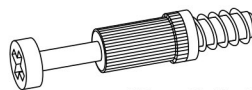

**K - 30 St.**

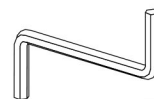

**Z - 1 St.**



**J - 16 St.**  
5x13 mm

I

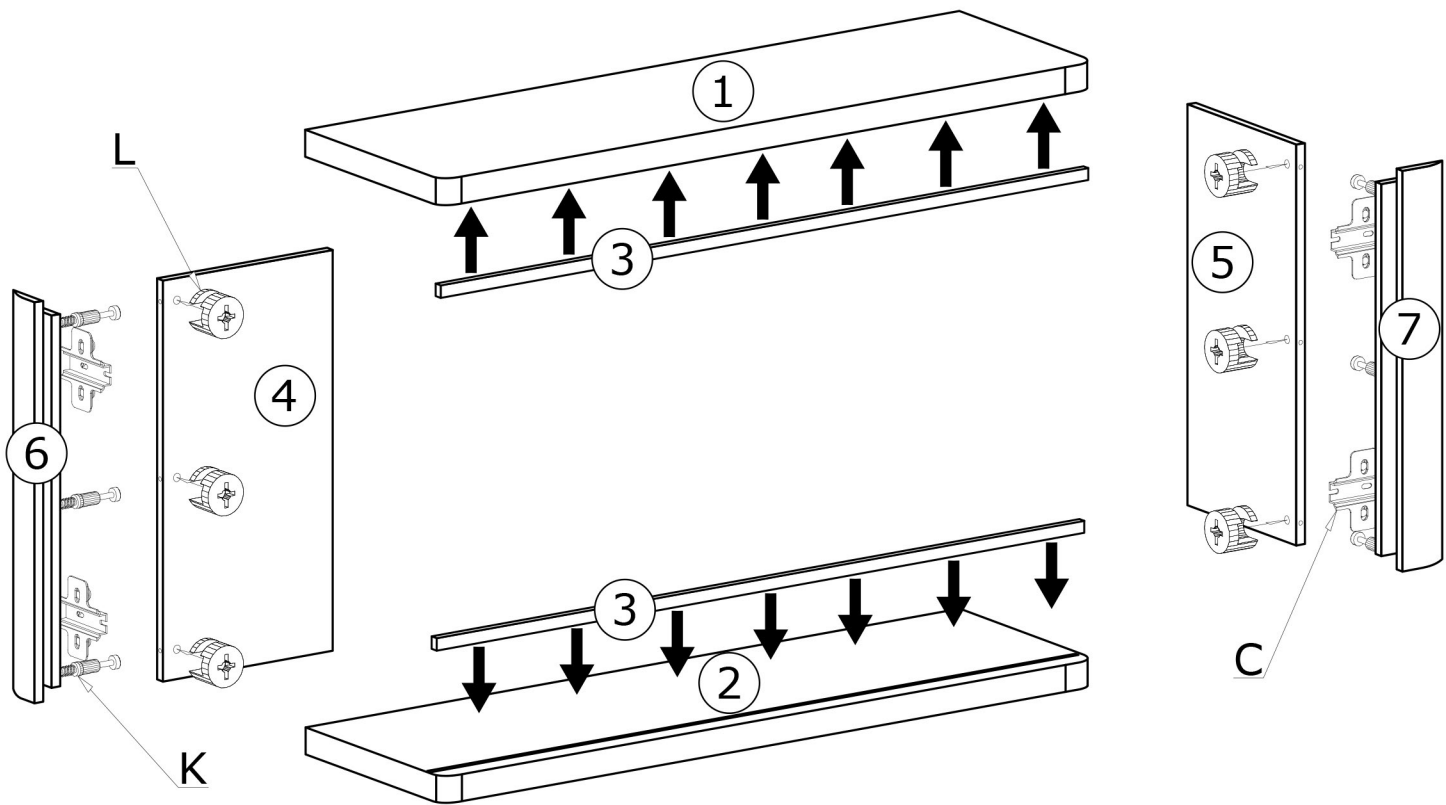

II

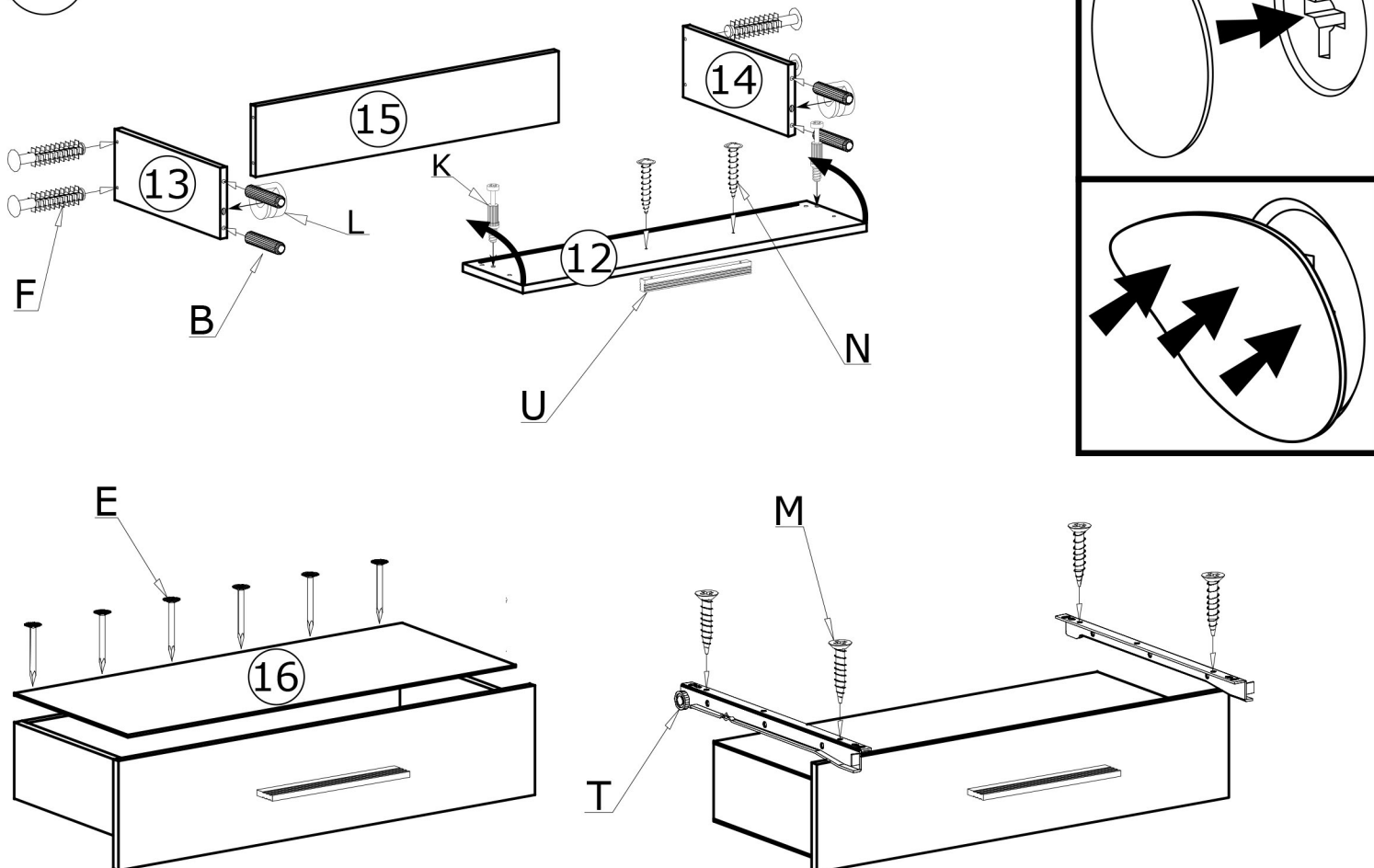

I

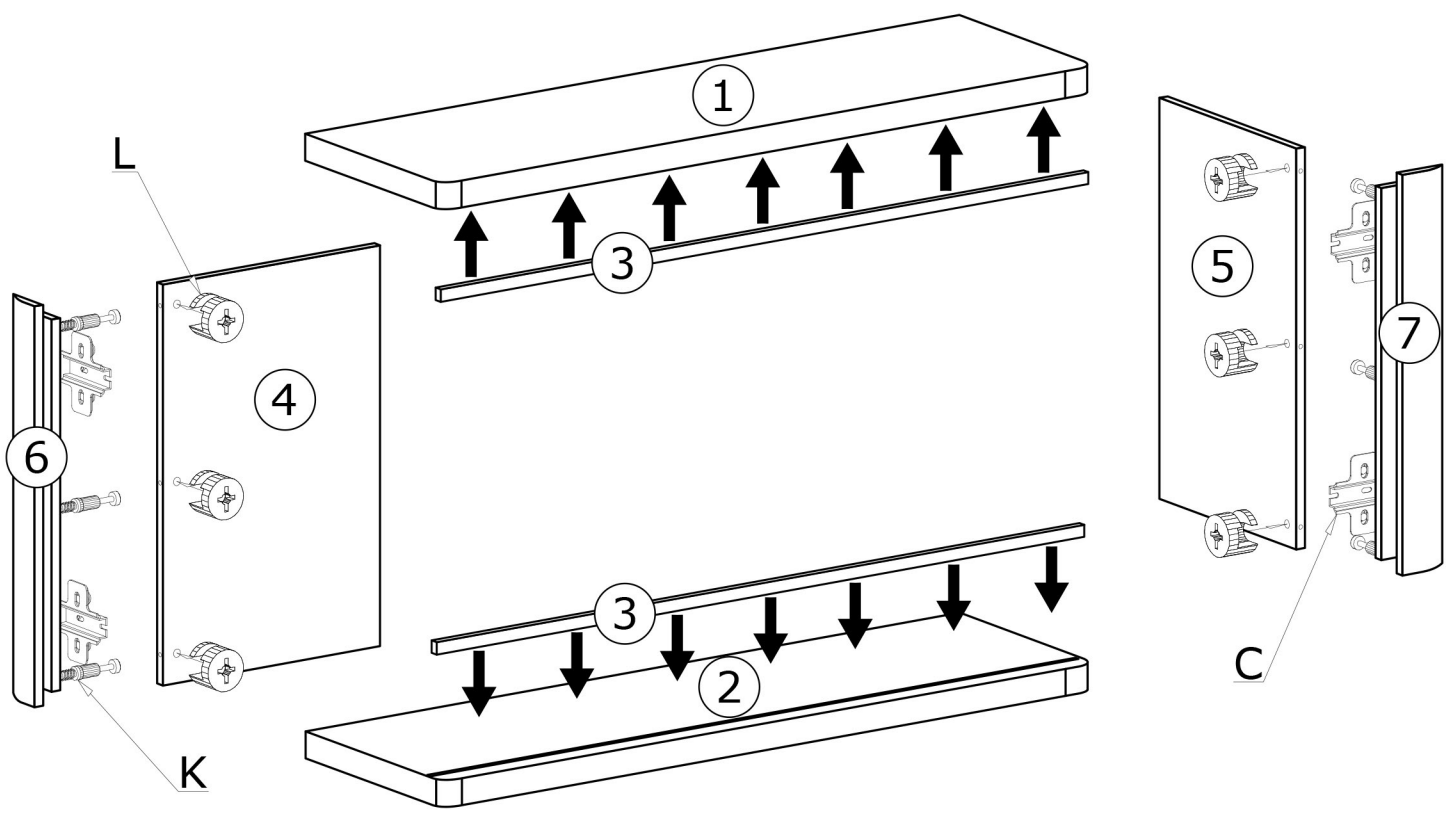

II

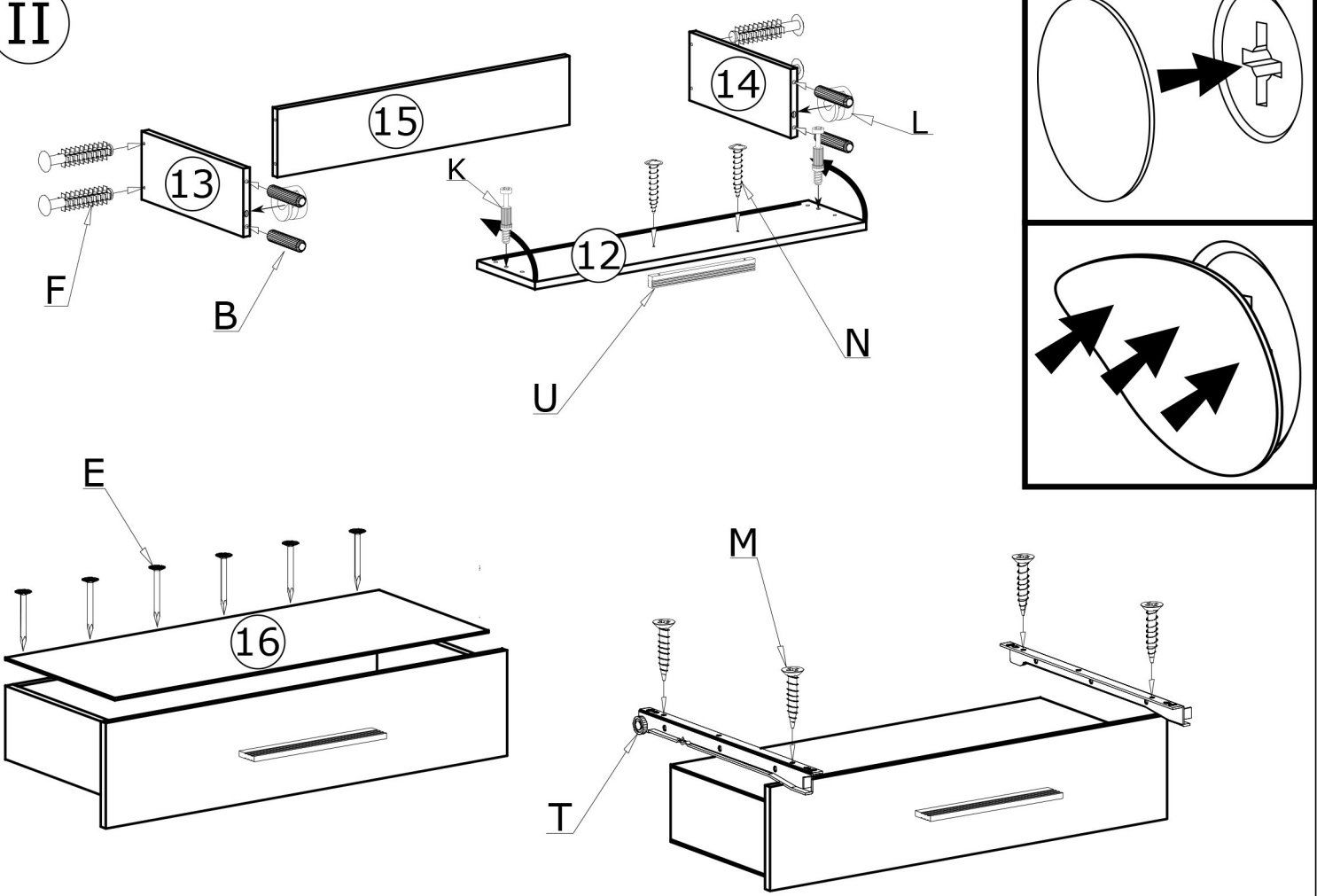

III

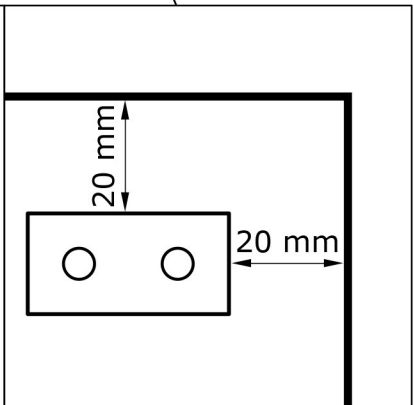
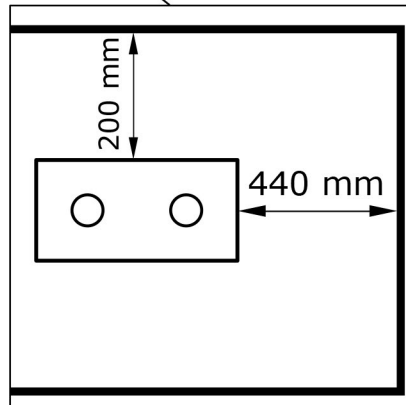
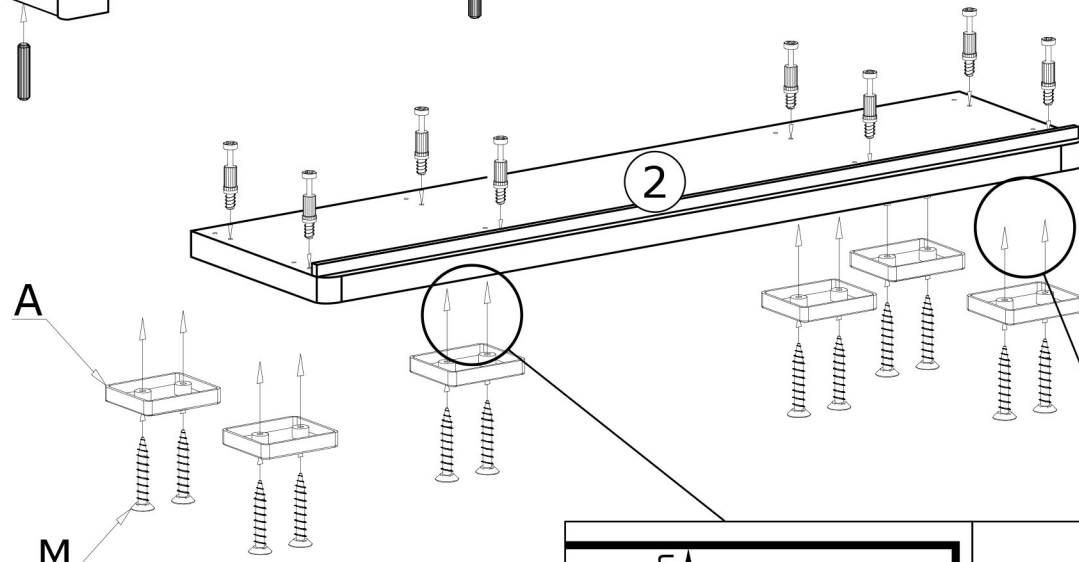
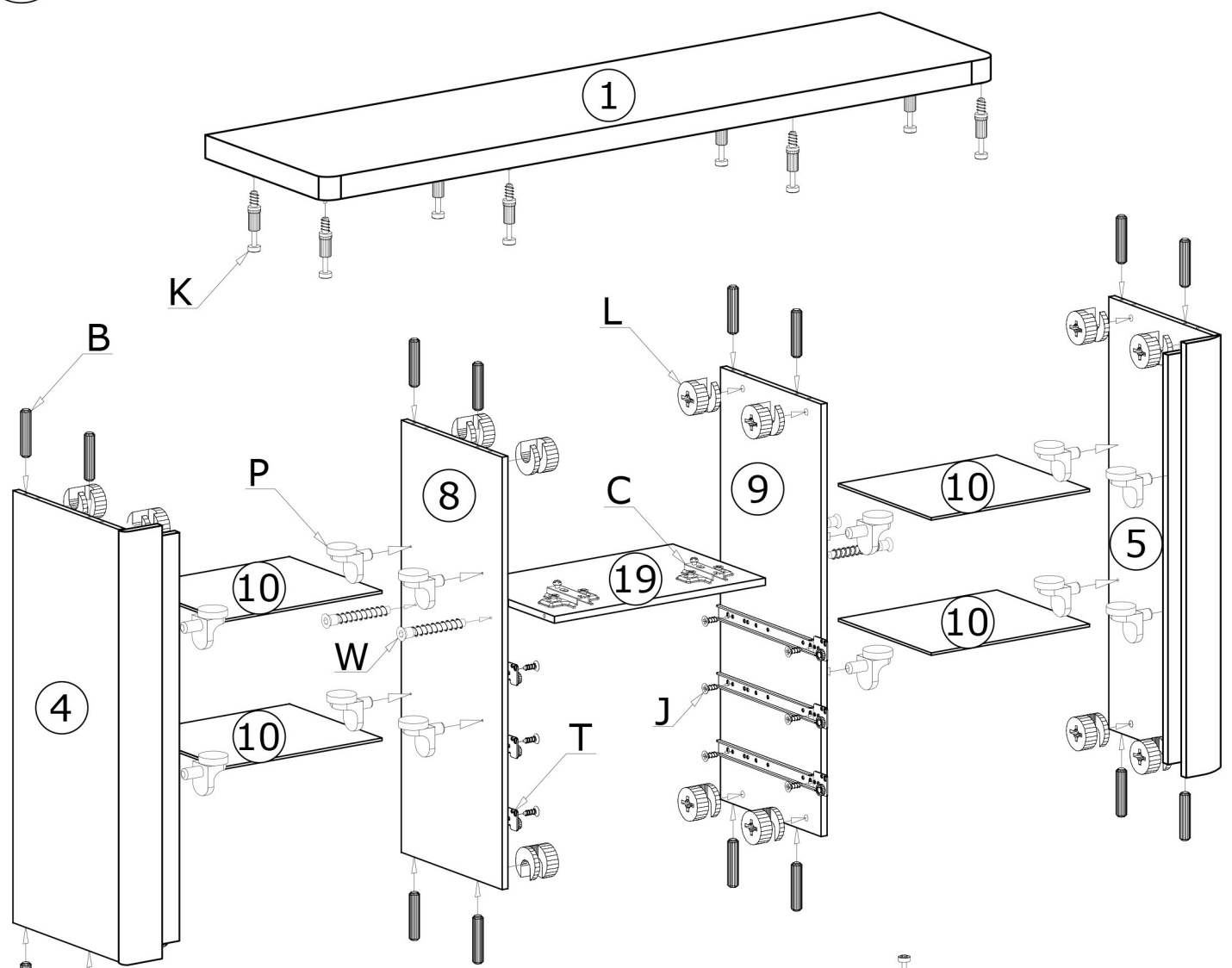

III

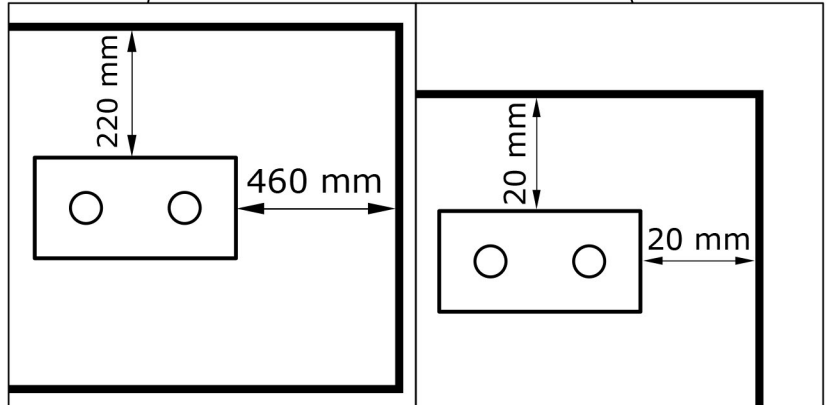
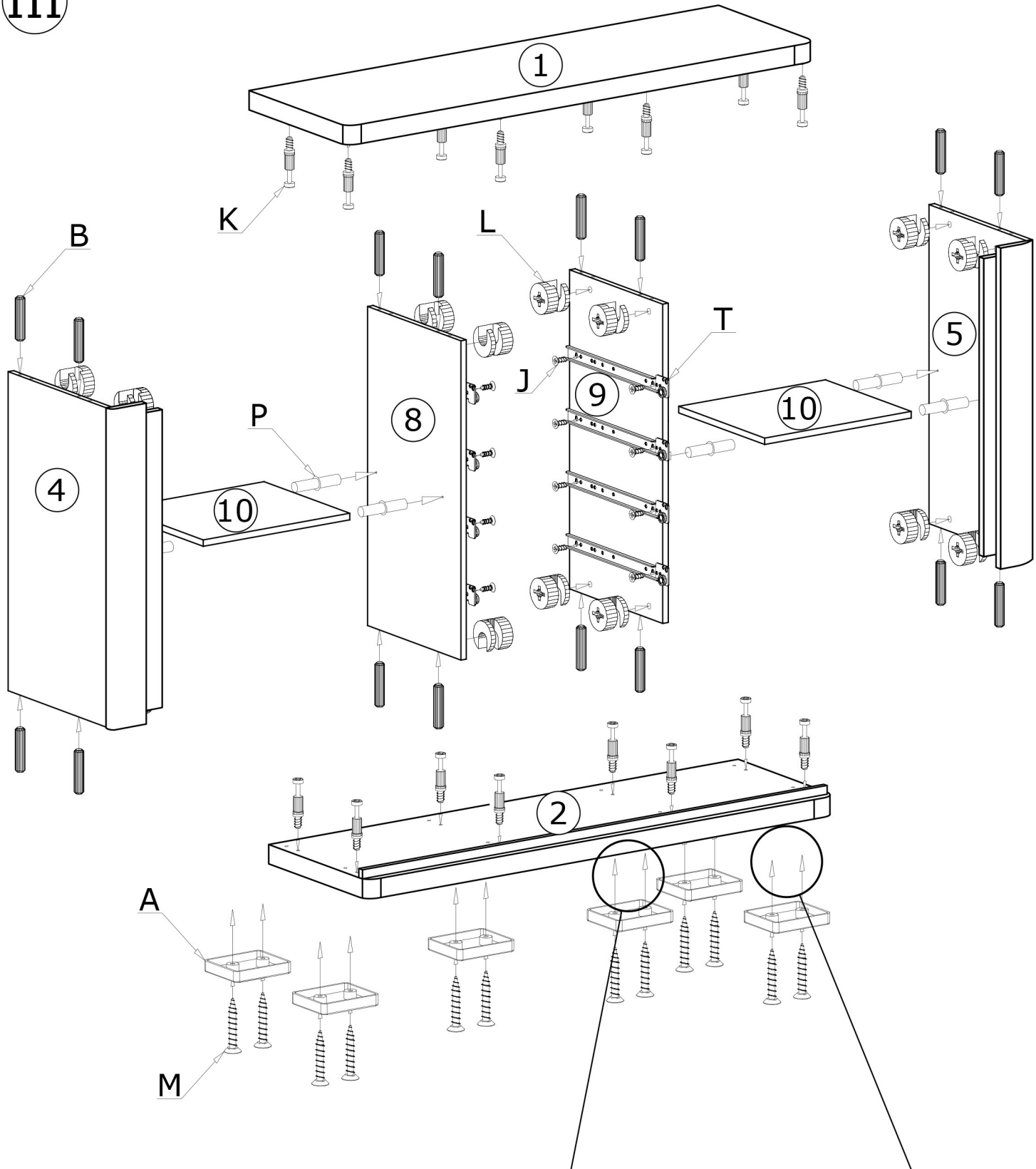

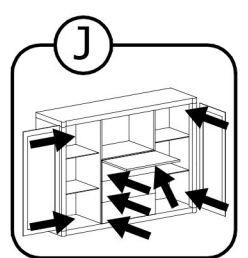
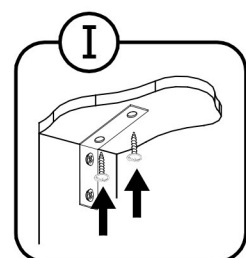
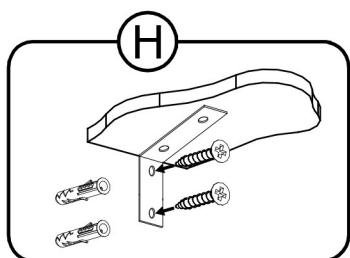
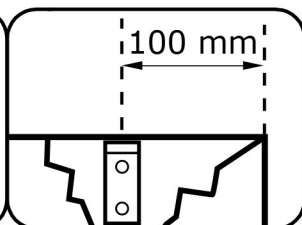
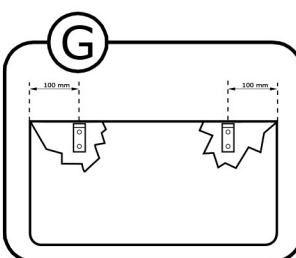
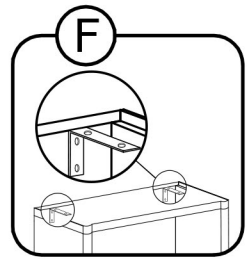
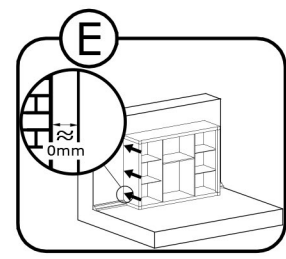
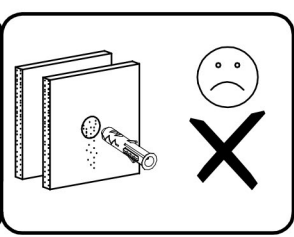
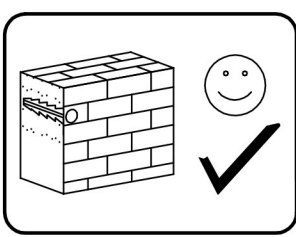
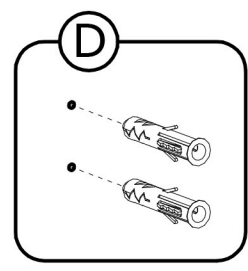
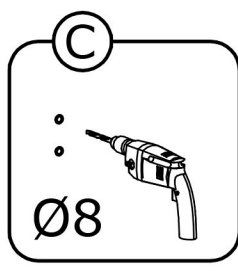
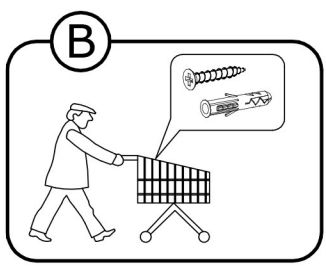
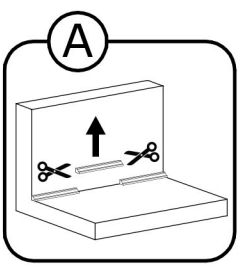
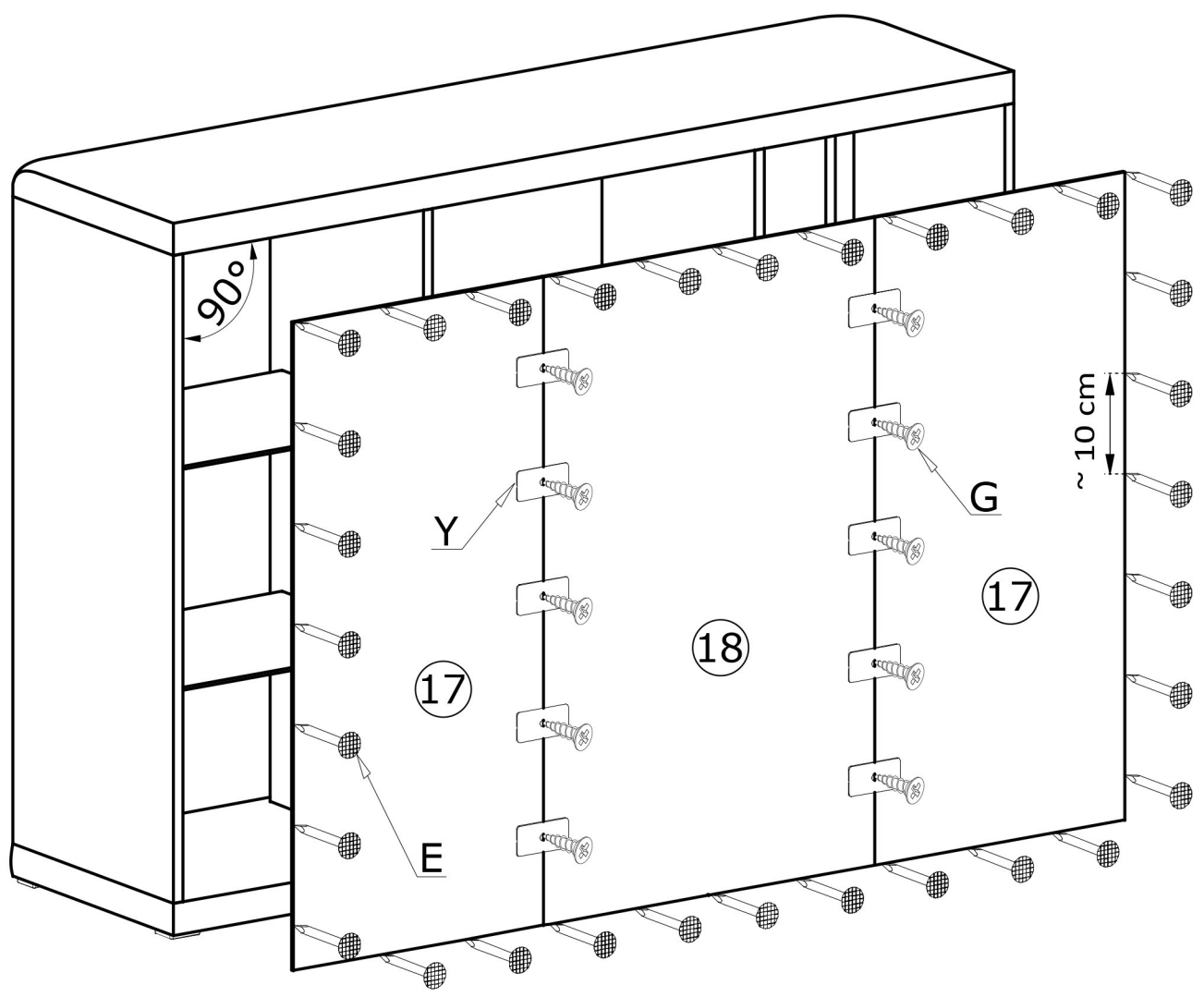

IV

90X 

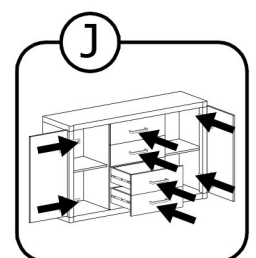
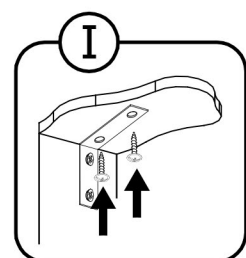
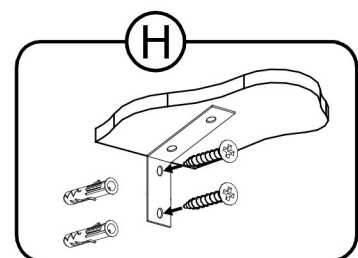
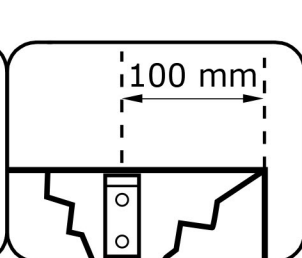
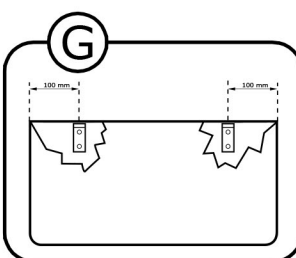
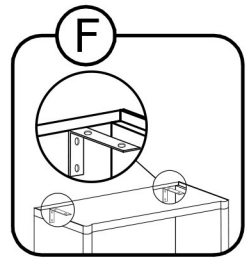
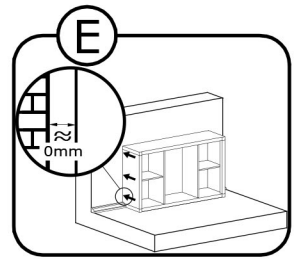
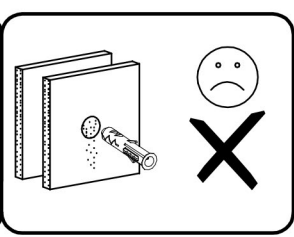
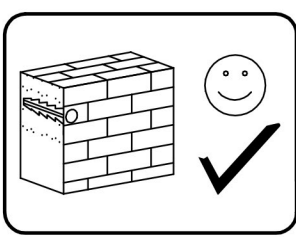
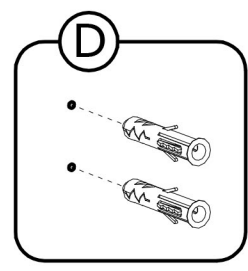
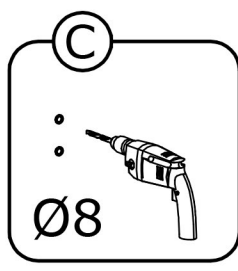
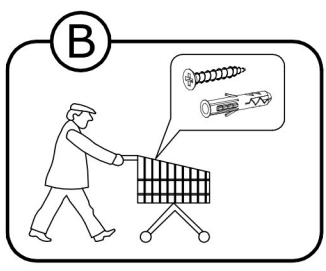
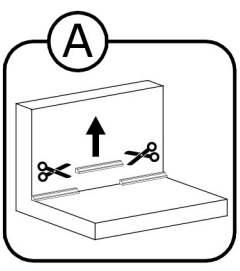
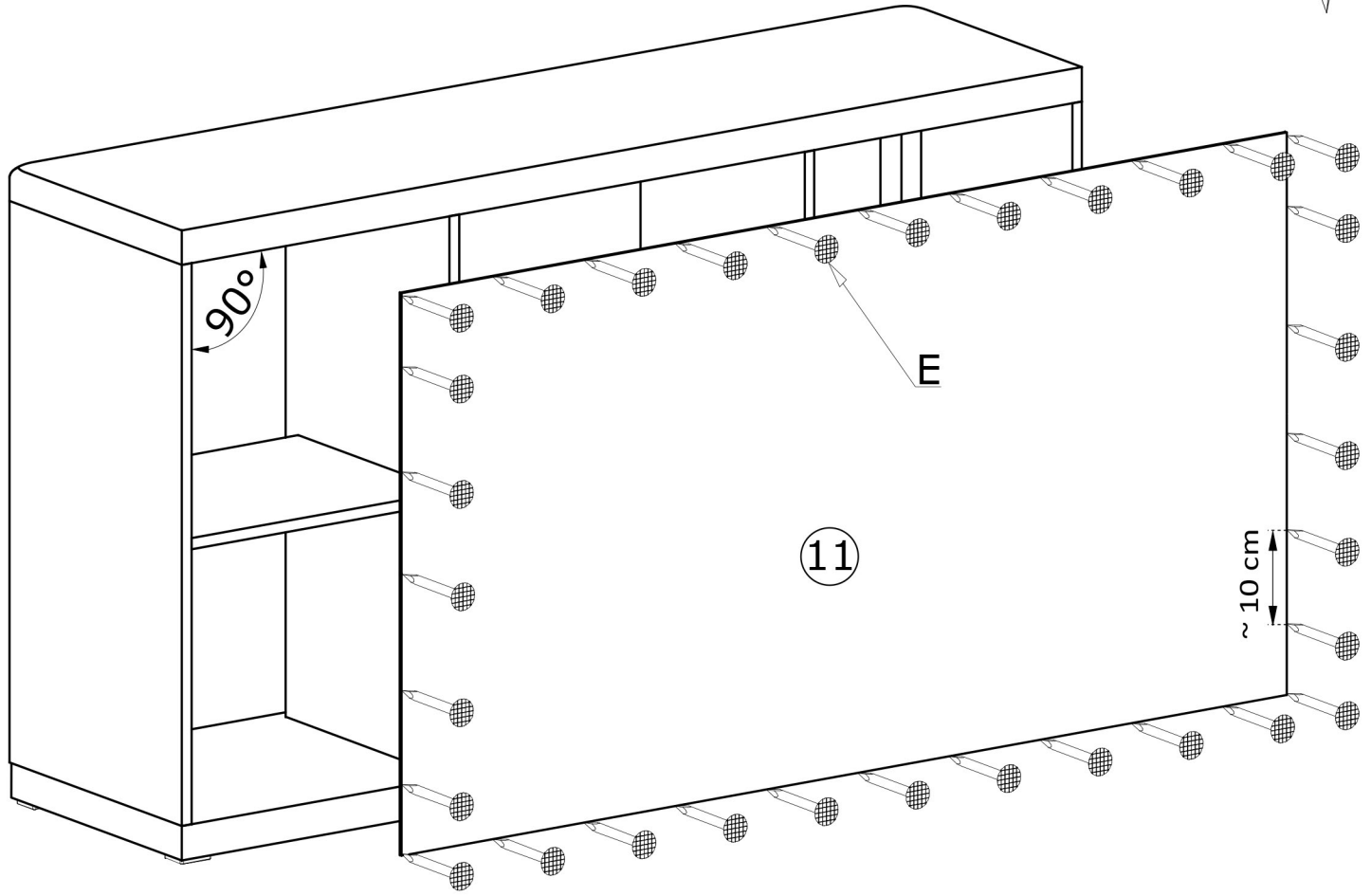



V

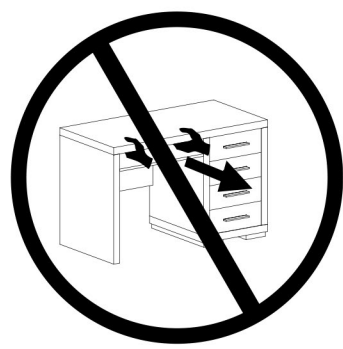
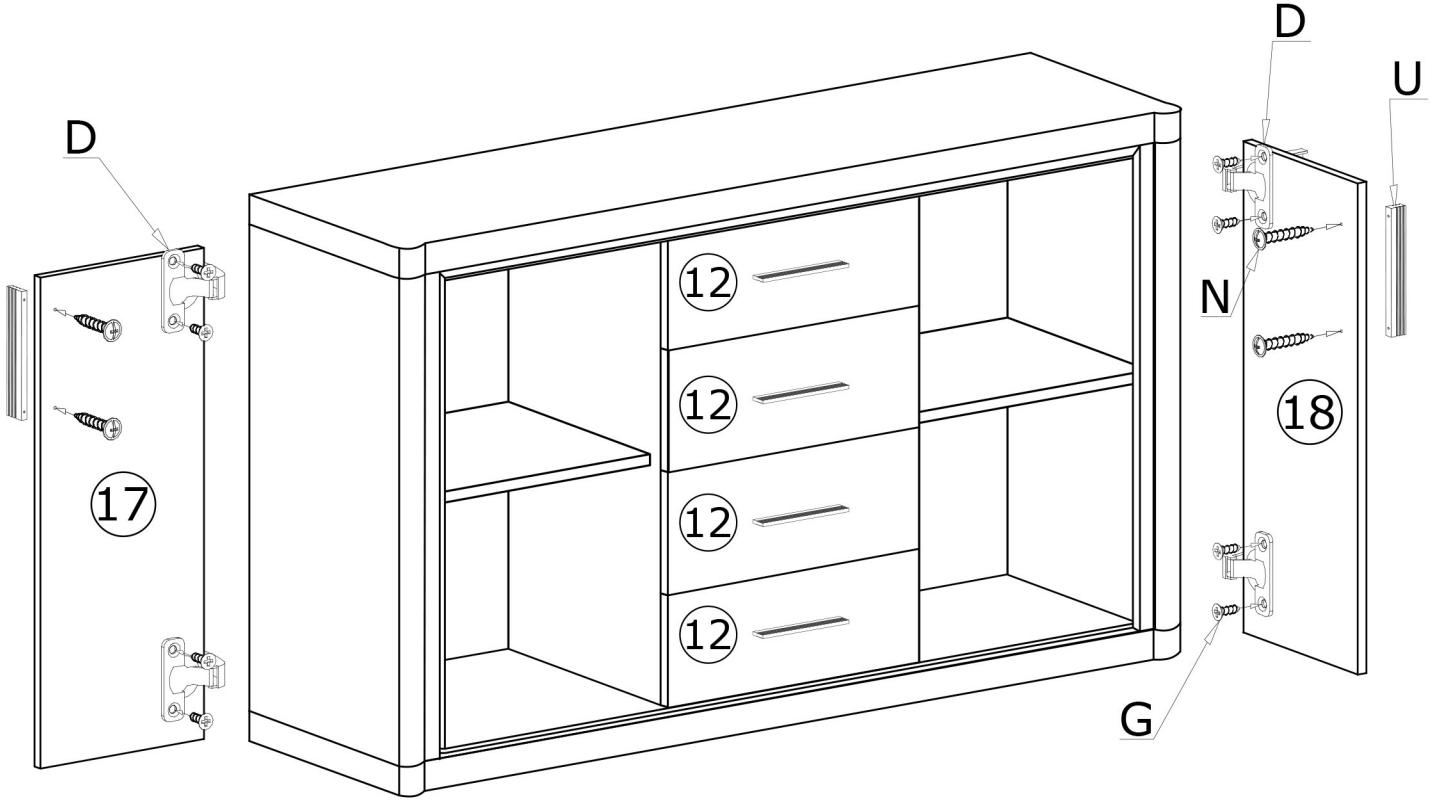
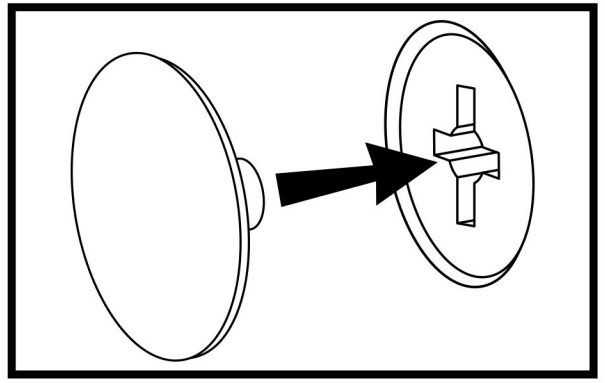

PL

**UWAGA!!!**

MONTOWANIE USZKODZONYCH ELEMENTÓW POWODUJE UTRATĘ GWARANCJI

**UWAGA!!!**

MEBEL ZAWIERA ELEMENTY DREWNIANE

W PRZYPADKU REKLAMACJI PROSZĘ PODAĆ NUMER PAKOWACZA ZNAJDUJĄCY SIĘ NA KARTONIE  
ODCIĘŃ DREWNA I UKŁAD SŁOI MOGĄ NIEZNACZNIE ODBIEGAĆ  
OD PREZENTOWANYCH NA ZDJĘCIACH KATALOGOWYCH

CZ

**UPOZORNĚNÍ!!!**

MONTÁŽ POŠKOZENÝCH KOMPONENTŮ RUŠÍ PLATNOU ZÁRUKU

**UPOZORNĚNÍ!!!**

NÁBYTEK OBSAHUJE DŘEVĚNÉ PRVKY

V PŘÍPADĚ REKLAMACE UVEĎTE PROSÍM ČÍSLO BALIČE, KTERÉ NAJDETE NA KRABICI  
ODSTÍN A KRESBA DŘEVA SE MOHOU VÝRAZNĚ LIŠIT  
OD TĚCH ZOBRAZENÝCH NA KATALOGOVÝCH FOTOGRAFIÍCH

DE

**BEACHTUNG!!!**

DER EINBAU BESCHÄDIGTER KOMPONENTEN SCHLIESST EINE GÜLTIGE GEWÄHRLEISTUNG AUS

**BEACHTUNG!!!**

MÖBEL ENTHALTEN HOLZELEMENTE

IM FALL EINER REKLAMATION GEBEN SIE BITTE DIE PAKETNUMMER AN,  
DIE SIE AUF DEM KARTON FINDEN  
HOLZSCHATTIERUNG UND HOLZZEICHNUNG KÖNNEN UNTERSCHIEDLICH  
VON DEN AUF DEN KATALOGFOTOS GEZEIGTEN ABWEICHEN

HR

**PAŽNJA!!!**

INSTALACIJA OŠTEĆENIH KOMPONENTI ZA POSLJEDICU IMA GUBITAK JAMSTVA

**PAŽNJA!!!**

NAMJEŠTAJ SADRŽI DRVENE ELEMENT

U SLUČAJU REKLAMACIJE, MOLIMO NAVESTI BROJ PAKIRANJA KOJI SE NALAZI NA KUTIJI  
NIJANSA DRVETA I RASPORED GODOVA MOGU MINIMALNO  
ODUDARATI OD ONIH NA KATALOŠKIM FOTOGRAFIJAMA

HU

**FIGYELEM!!!**

SÉRÜLT ALKATRÉSZEK BEÉPÍTÉSE ESETÉN A GARANCIA ÉRVÉNYÉT VESZTI

**FIGYELEM!!!**

A BÚTOROK FA ELEMÉKET TARTALMAZNAK

REKLAMÁCIÓ ESETÉN KÉRJÜK, ADJA MEG A DOBOZON TALÁLHATÓ CSOMAGOLÁSI SZÁMOT  
A FA ÁRNYALATA ÉS A CSOMÓK ELRENDEZÉSE  
JELENTŐSEN ELTÉRHET A KATALÓGUSBAN SZEREPLŐ KÉPEKTŐL

SK

**UPOZORNENIE!!!**

INŠTALÁCIOU POŠKODENÝCH KOMPONENTOV SA RUŠÍ ZÁRUKA

**UPOZORNENIE!!!**

NÁBYTOK OBSAHUJE DREVENÉ PRVKY

V PRÍPADE REKLAMÁCIÍ UVEĎTE ČÍSLO BALENIA NÁJDENÉ NA KRABICI  
ODTIEŇ DŘEVA A USPORIADANIE UZLOV  
SA MÔŽE VÝRAZNE LIŠIŤ OD KATALÓGOVÝCH OBRÁZKOV

SR

**PAŽNJA!!!**

MONTAŽA OŠTEĆENIH DELOVA DOVODI DO GUBITKA GARANCIJE

**PAŽNJA!!!**

NAMEŠTAJ SADRŽI DRVENE DELOVE

U SLUČAJU REKLAMACIJA MOLIMO DA DOSTAVITE PAKER BROJ KOJI SE NALAZI NA KARTONU  
NIJANSA BOJE DRVETA I RASPORED SLOJEVA MOGU NEZNATNO  
DA SE RAZLIKUJU OD PREZENTOVANIH NA SLIKAMA U KATALOGU