

# KORA 16

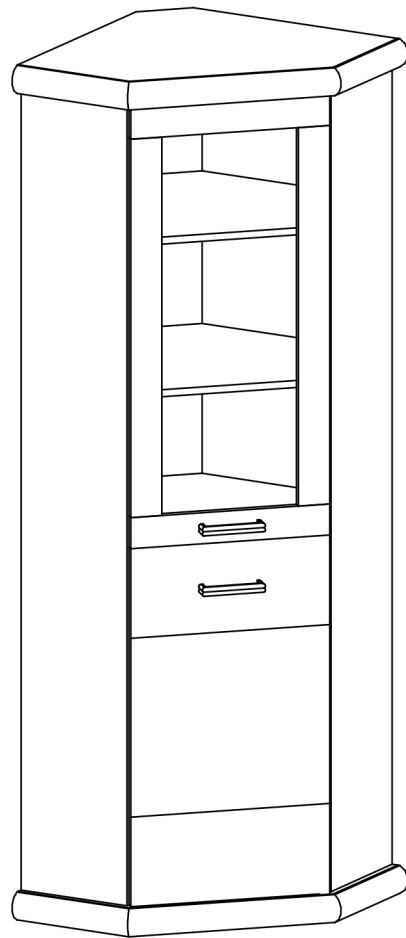

Nr	D[mm]	S[mm]	G[mm]	
1	625	625	65	1
2	625	625	65	1
3	1835	268	16	1
4	1835	268	16	1
5	1835	195	16	1
6	578	578	16	3
7	578	578	16	1
8	1860	468	2,5	2
9	1005	443	16	1
10	773	443	16	1

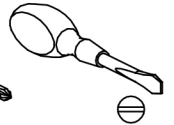
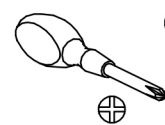
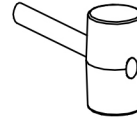
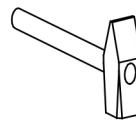
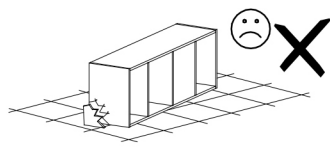
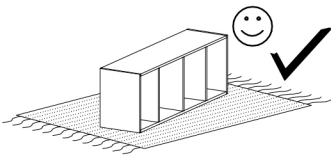
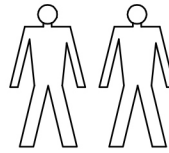
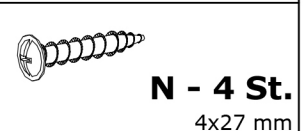
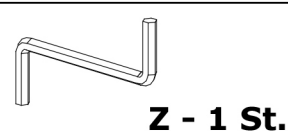
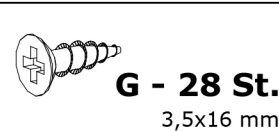
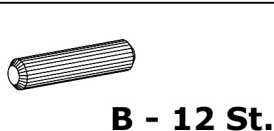
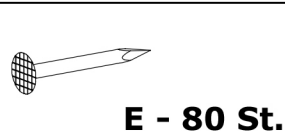
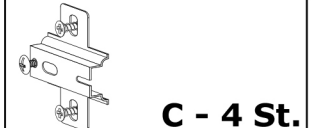
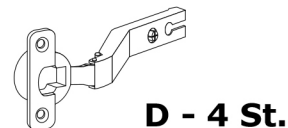
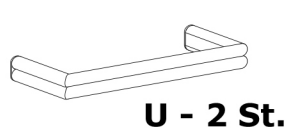
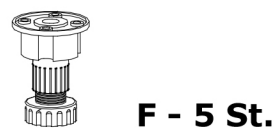
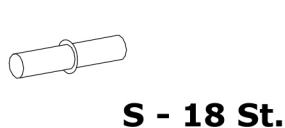
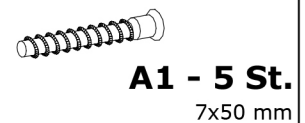
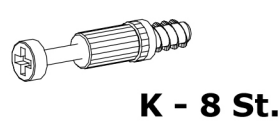
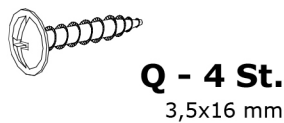
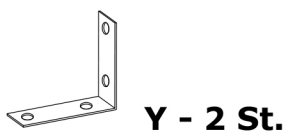

I

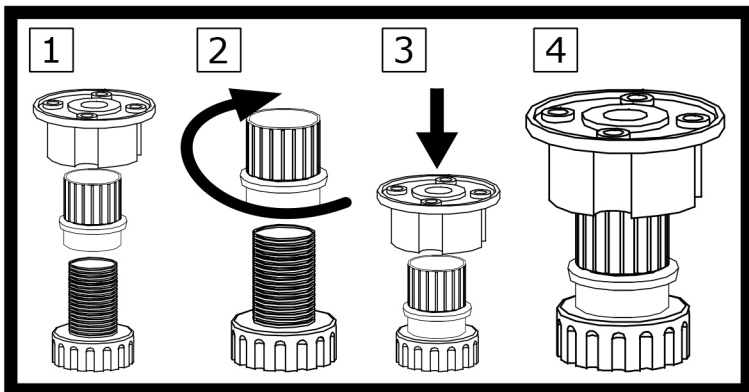
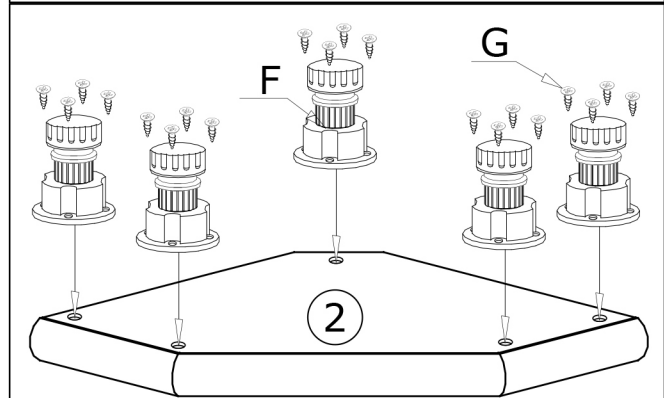
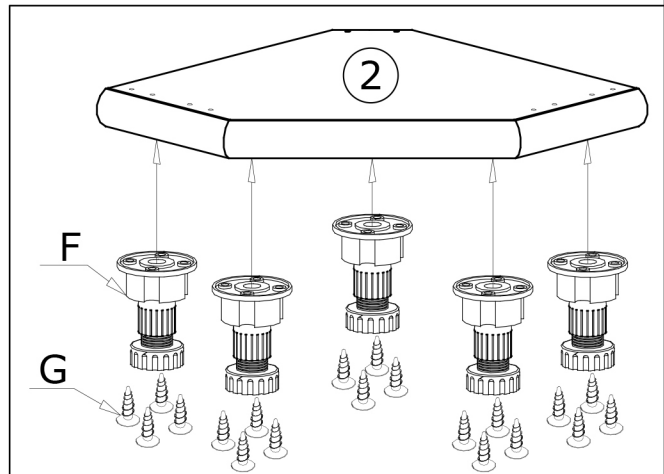
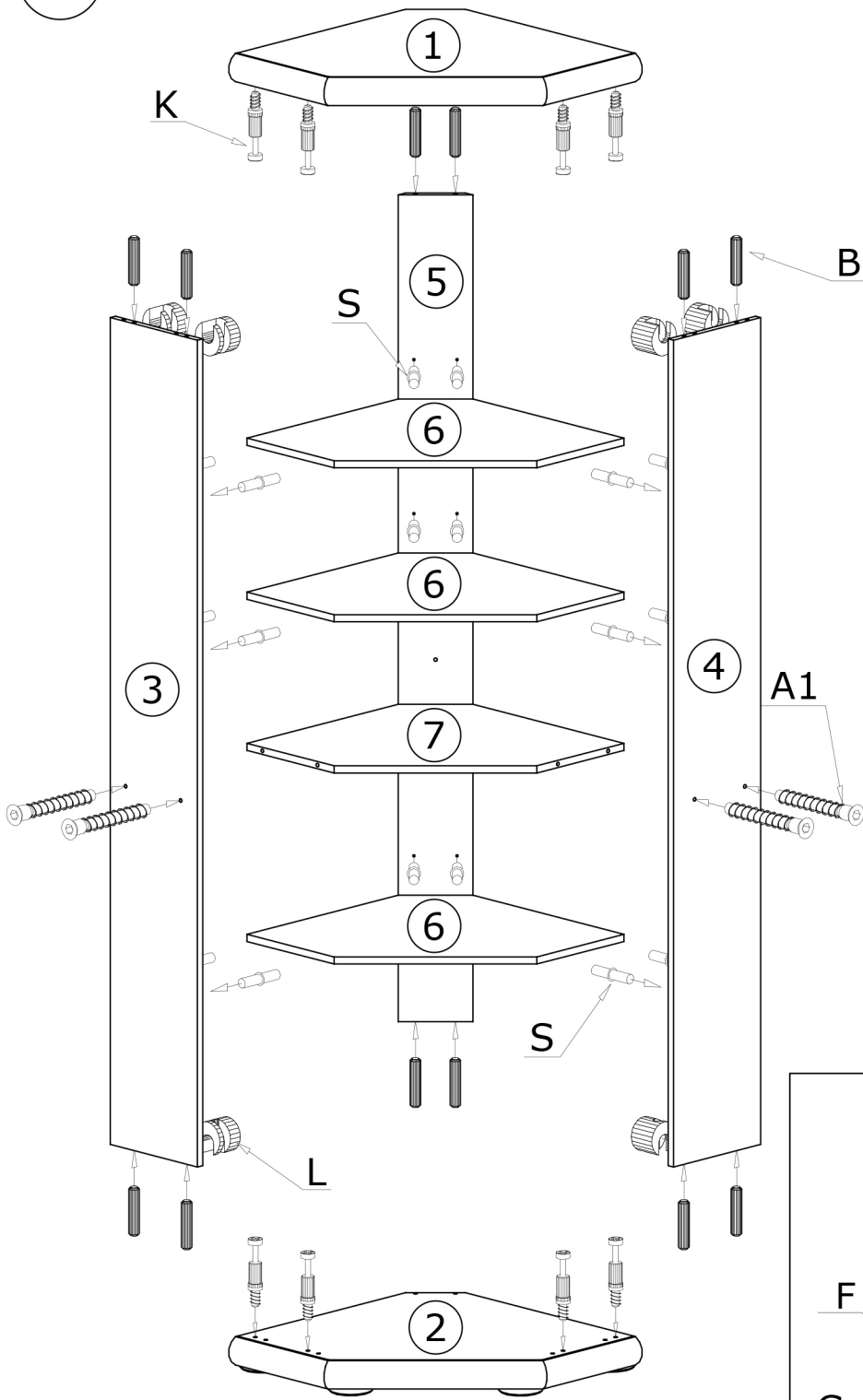

II

80X 

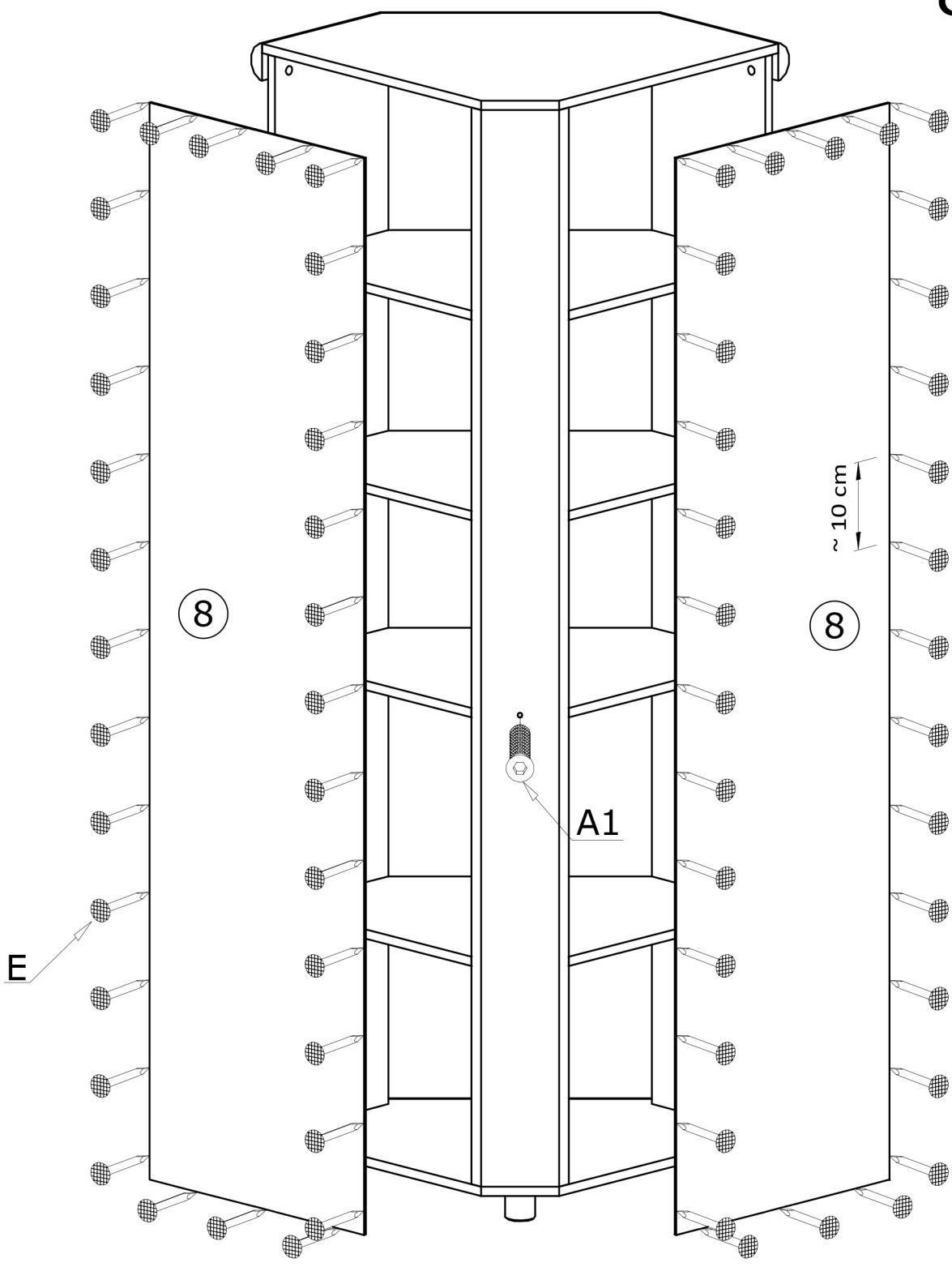

# III

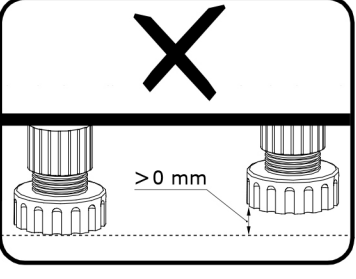
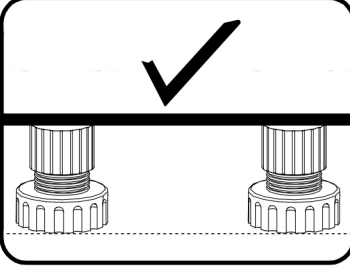
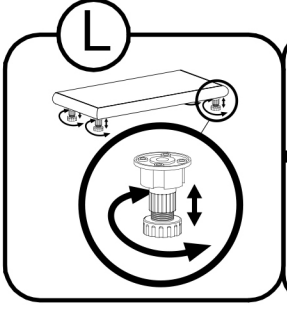
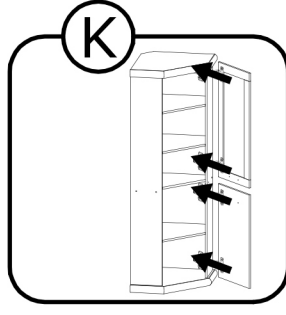
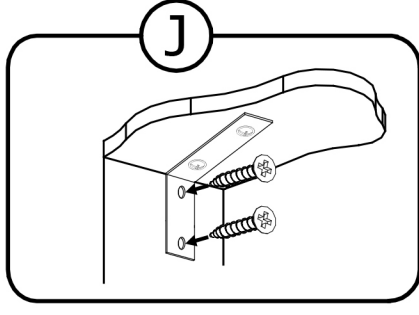
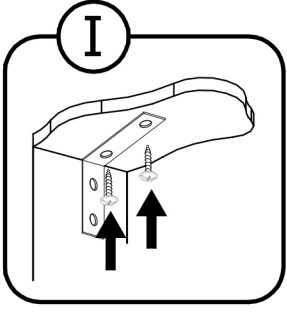
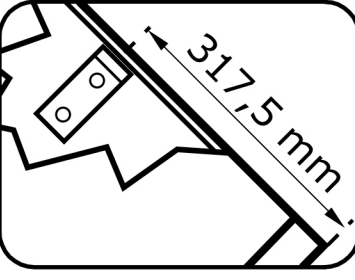
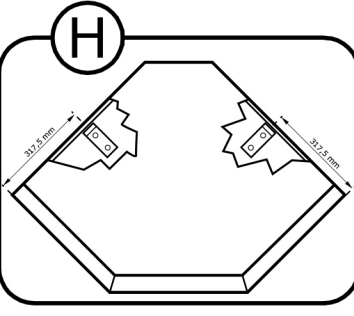
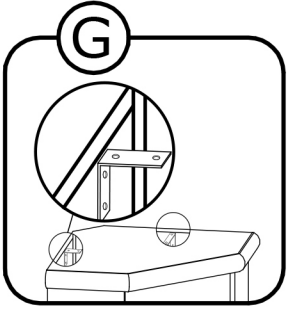
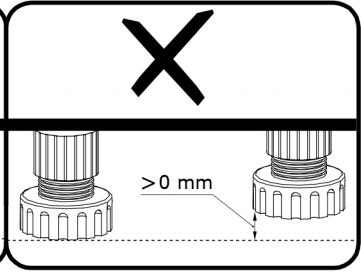
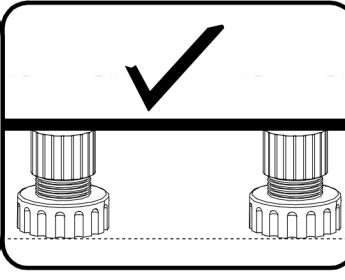
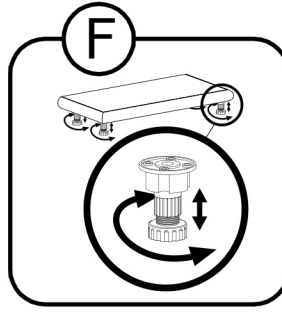
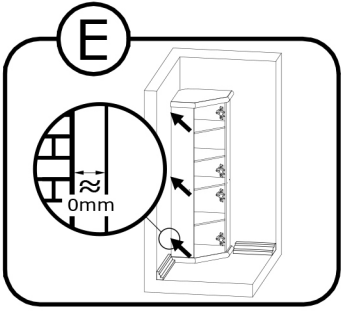
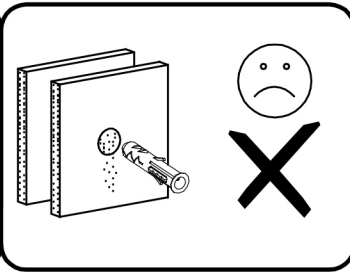
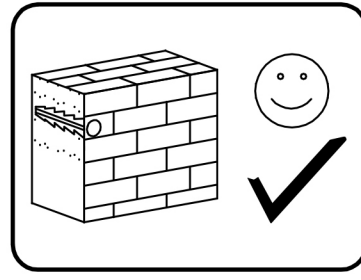
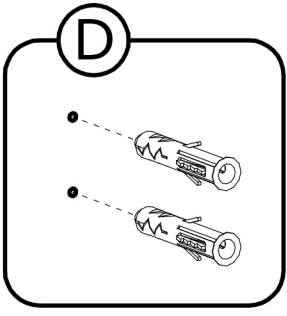
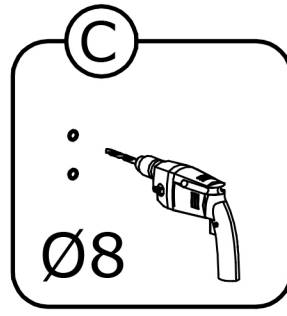
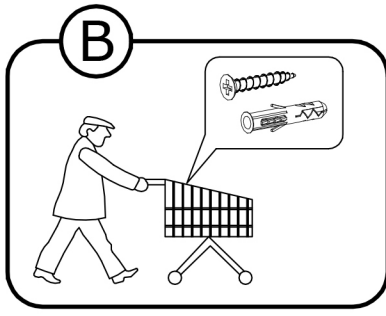
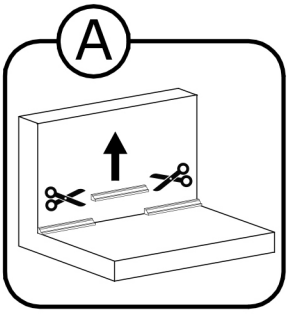

IV

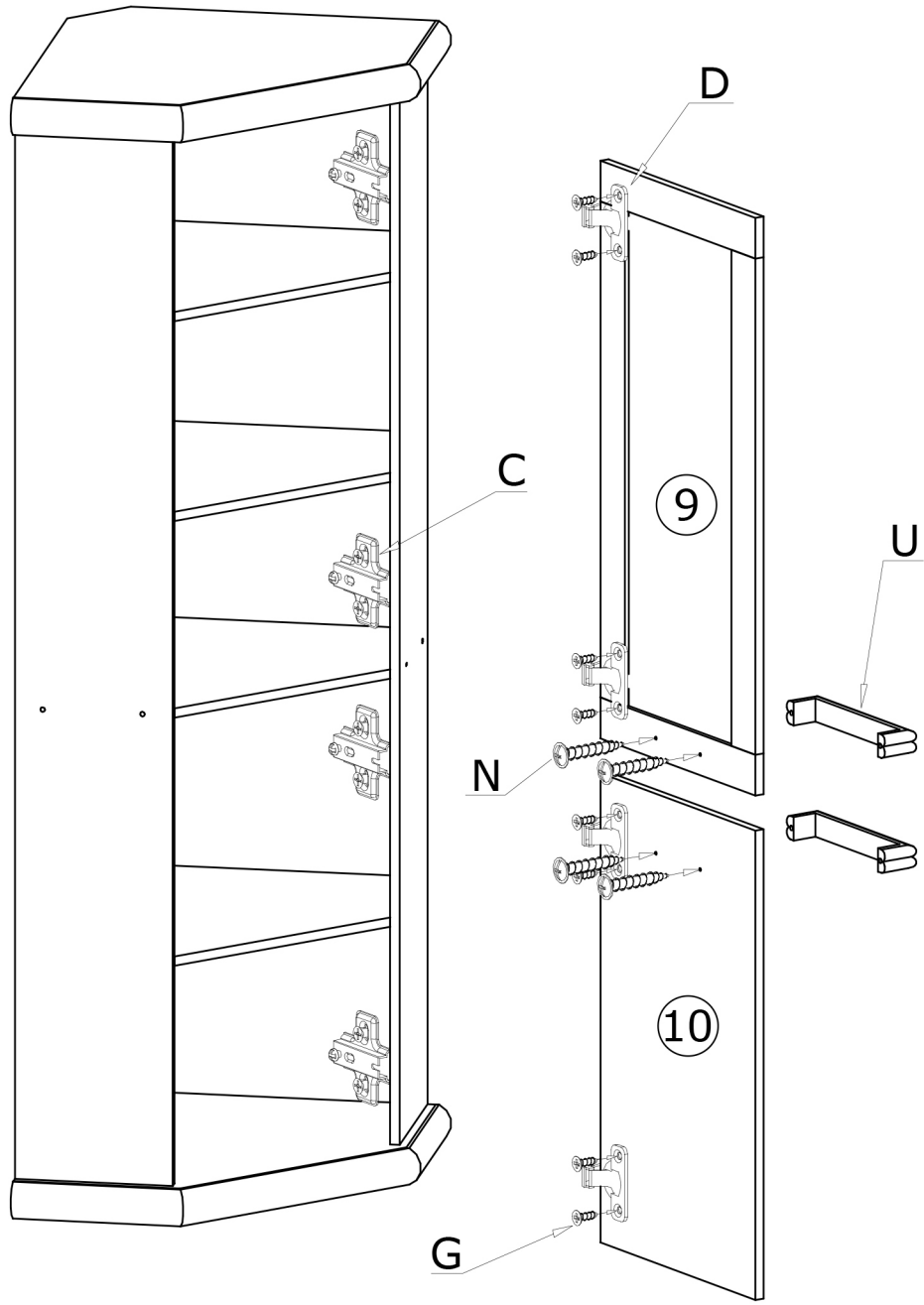

PL

**UWAGA!!!**

MONTOWANIE USZKODZONYCH ELEMENTÓW POWODUJE UTRATĘ GWARANCJI

**UWAGA!!!**

MEBEL ZAWIERA ELEMENTY DREWNIANE

W PRZYPADKU REKLAMACJI PROSZĘ PODAĆ NUMER PAKOWACZA ZNAJDUJĄCY SIĘ NA KARTONIE  
ODCIEŃ DREWNA I UKŁAD SŁOI MOGĄ NIEZNACZNIE ODBIEGAĆ  
OD PREZENTOWANYCH NA ZDJĘCIACH KATALOGOWYCH

CZ

**UPOZORNĚNÍ!!!**

MONTÁŽ POŠKOZENÝCH KOMPONENTŮ RUŠÍ PLATNOU ZÁRUKU

**UPOZORNĚNÍ!!!**

NÁBYTEK OBSAHUJE DŘEVĚNÉ PRVKY

V PŘÍPADĚ REKLAMACE UVEĎTE PROSÍM ČÍSLO BALIČE, KTERÉ NAJDETE NA KRABICI  
ODSTÍN A KRESBA DŘEVA SE MOHOU VÝRAZNĚ LIŠIT  
OD TĚCH ZOBRAZENÝCH NA KATALOGOVÝCH FOTOGRAFIÍCH

DE

**BEACHTUNG!!!**

DER EINBAU BESCHÄDIGTER KOMPONENTEN SCHLIESST EINE GÜLTIGE GEWÄHRLEISTUNG AUS

**BEACHTUNG!!!**

MÖBEL ENTHALTEN HOLZELEMENTE

IM FALL EINER REKLAMATION GEBEN SIE BITTE DIE PAKETNUMMER AN,  
DIE SIE AUF DEM KARTON FINDEN  
HOLZSCHATTIERUNG UND HOLZZEICHNUNG KÖNNEN UNTERSCHIEDLICH  
VON DEN AUF DEN KATALOGFOTOS GEZEIGTEN ABWEICHEN

HR

**PAŽNJA!!!**

INSTALACIJA OŠTEĆENIH KOMPONENTI ZA POSLJEDICU IMA GUBITAK JAMSTVA

**PAŽNJA!!!**

NAMJEŠTAJ SADRŽI DRVENE ELEMENT

U SLUČAJU REKLAMACIJE, MOLIMO NAVESTI BROJ PAKIRANJA KOJI SE NALAZI NA KUTIJI  
NIJANSA DRVETA I RASPORED GODOVA MOGU MINIMALNO  
ODUDARATI OD ONIH NA KATALOŠKIM FOTOGRAFIJAMA

HU

**FIGYELEM!!!**

SÉRÜLT ALKATRÉSZEK BEÉPÍTÉSE ESETÉN A GARANCIA ÉRVÉNYÉT VESZTI

**FIGYELEM!!!**

A BÚTOROK FA ELEMÉKET TARTALMAZNAK

REKLAMÁCIÓ ESETÉN KÉRJÜK, ADJA MEG A DOBOZON TALÁLHATÓ CSOMAGOLÁSI SZÁMOT  
A FA ÁRNYALATA ÉS A CSOMÓK ELRENDEZÉSE  
JELENTŐSEN ELTÉRHET A KATALÓGUSBAN SZEREPLŐ KÉPEKTŐL

SK

**UPOZORNENIE!!!**

INŠTALÁCIU POŠKODENÝCH KOMPONENTOV SA RUŠÍ ZÁRUKA

**UPOZORNENIE!!!**

NÁBYTOK OBSAHUJE DREVENÉ PRVKY

V PRÍPADE REKLAMÁCIÍ UVEĎTE ČÍSLO BALENIA NÁJDENÉ NA KRABICI  
ODTIEŇ DŘEVA A USPORIADANIE UZLOV  
SA MÔŽE VÝRAZNE LIŠIŤ OD KATALÓGOVÝCH OBRÁZKOV

SR

**PAŽNJA!!!**

MONTAŽA OŠTEĆENIH DELOVA DOVODI DO GUBITKA GARANCIJE

**PAŽNJA!!!**

NAMEŠTAJ SADRŽI DRVENE DELOVE

U SLUČAJU REKLAMACIJA MOLIMO DA DOSTAVITE PAKER BROJ KOJI SE NALAZI NA KARTONU  
NIJANSA BOJE DRVETA I RASPORED SLOJEVA MOGU NEZNATNO  
DA SE RAZLIKUJU OD PREZENTOVANIH NA SLIKAMA U KATALOGU