

# TADEUSZ 7

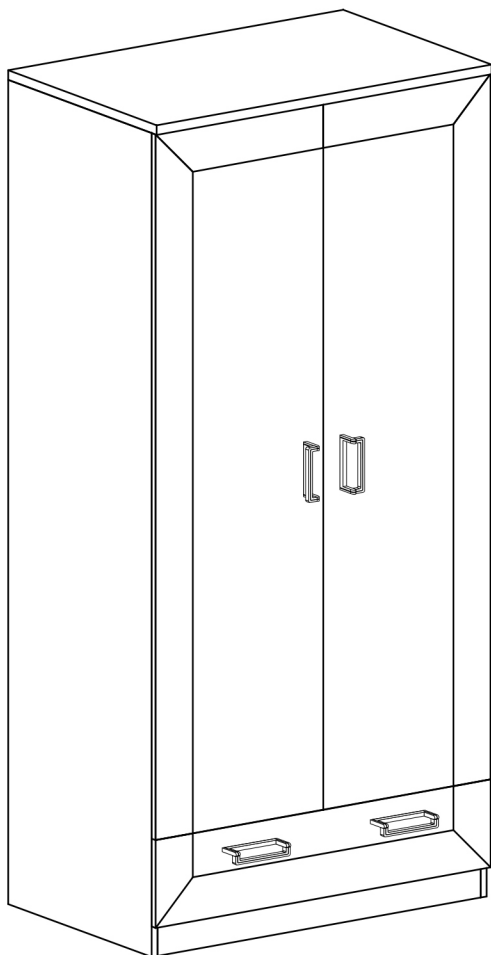

Nr	D[mm]	S[mm]	G[mm]	
1	900	575	32	1
2	851	540	16	1
3	851	540	16	1
4	853	80	16	1
5	1800	876	2,5	1
6	1870	540	16	1
7	1870	540	16	1
8	1586	438	16	1
9	1586	438	16	1
10	880	190	16	1
11	500	150	16	1
12	500	150	16	1
13	796	150	16	1
14	825	505	2,5	1

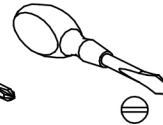
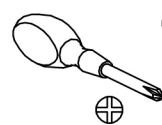
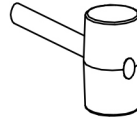
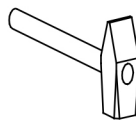
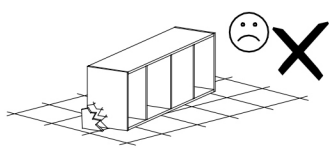
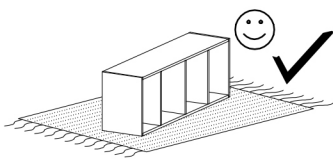
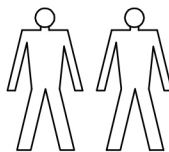
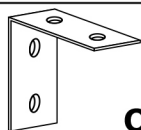

**O - 1 St.**

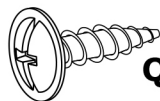

**Q - 2 St.**  
3,5x16 mm



**X1 - 8 St.**



**X2 - 9 St.**

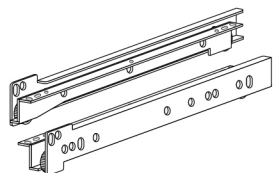

**T - 1 Kpl.**



**M - 4 St.**  
4x25 mm

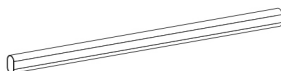

**R - 1 St.**

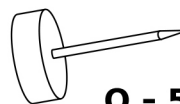

**Q - 5 St.**

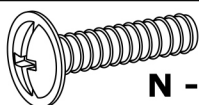

**N - 8 St.**  
4x22 mm

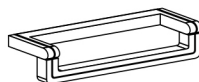

**U - 4 St.**

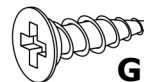

**G - 16 St.**  
3,5x16 mm

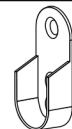

**Y - 2 St.**

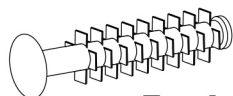

**F - 4 St.**



**E - 60 St.**

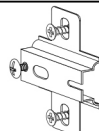

**C - 6 St.**

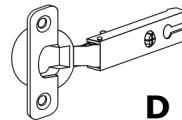

**D - 6 St.**



**L - 8 St.**

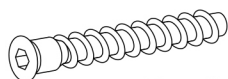

**R - 9 St.**

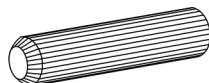

**B - 20 St.**

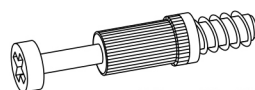

**K - 8 St.**

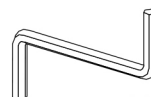

**Z - 1 St.**

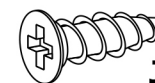

**J - 4 St.**  
5x13 mm

I

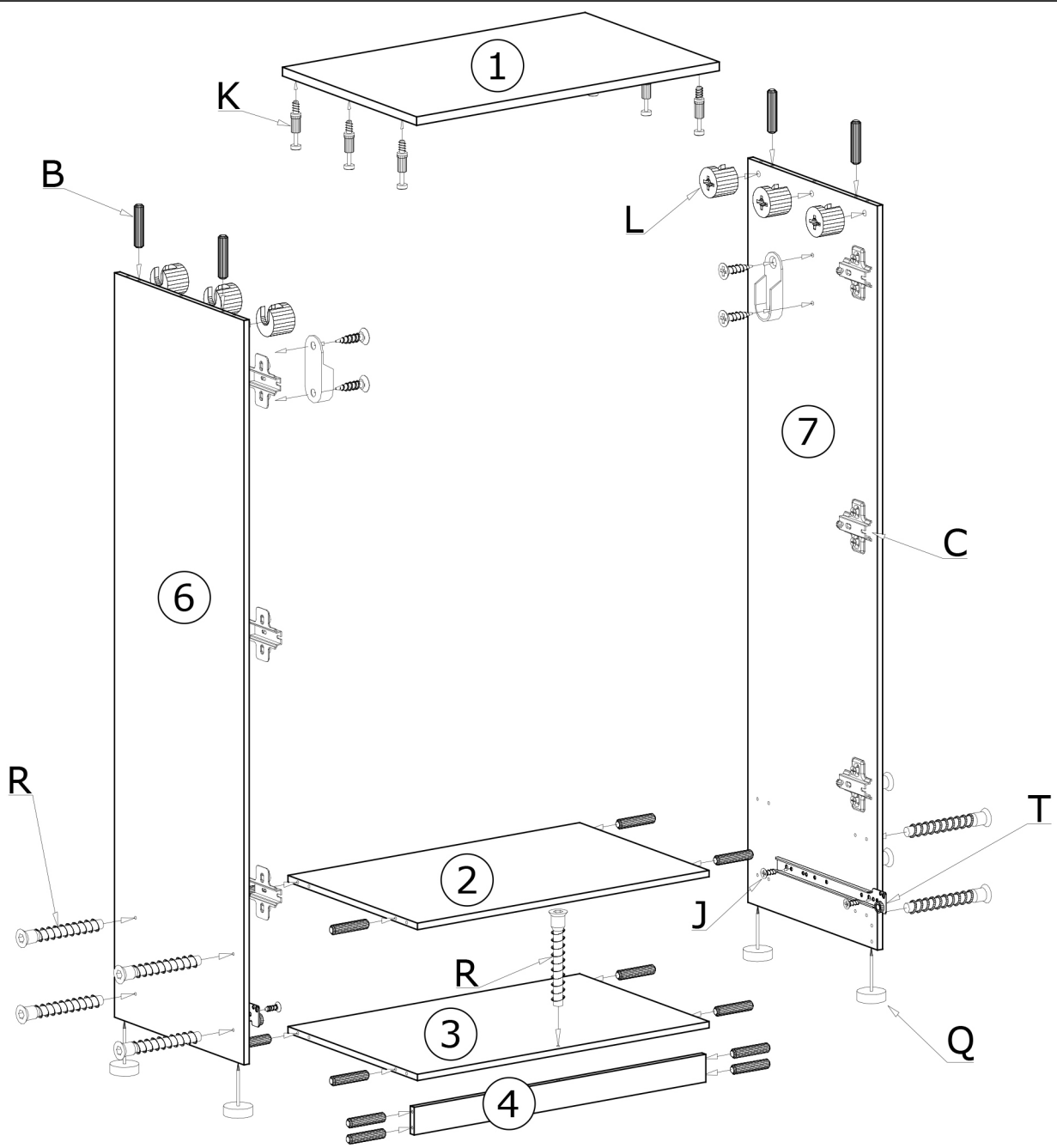

II

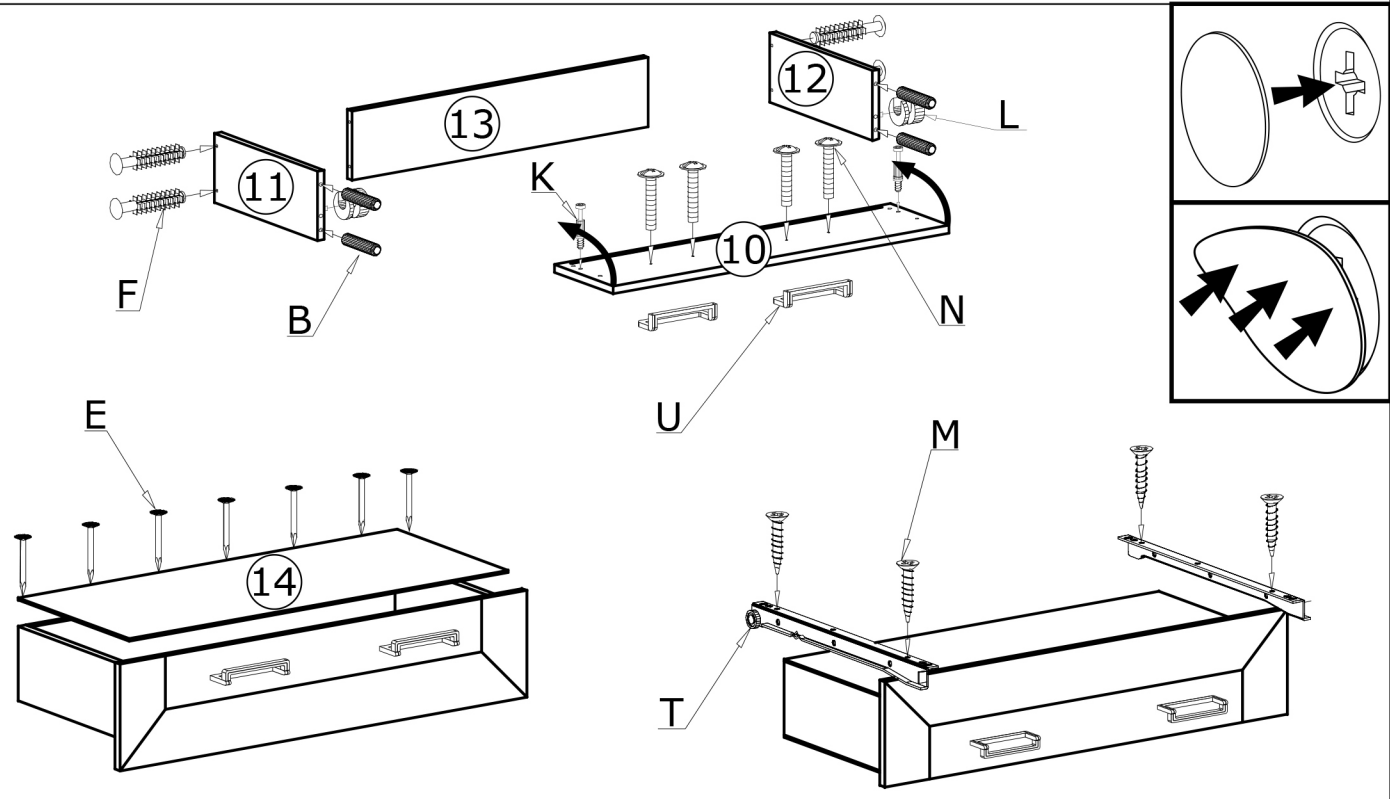

III

60X 

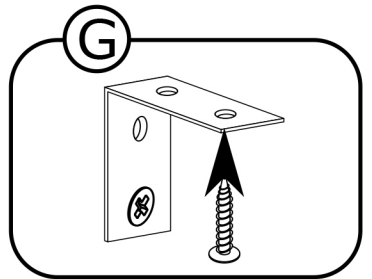
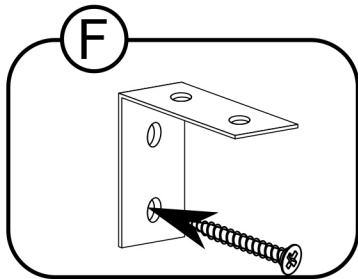
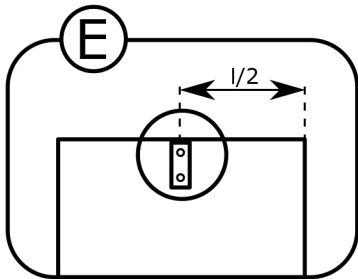
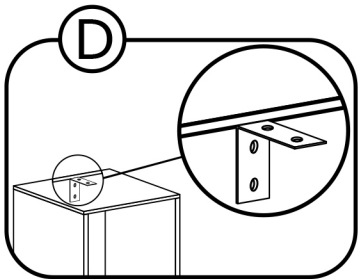
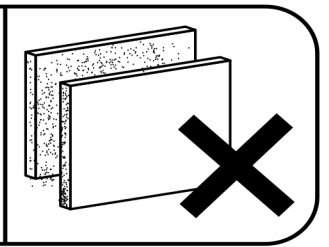
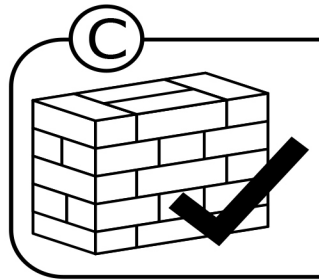
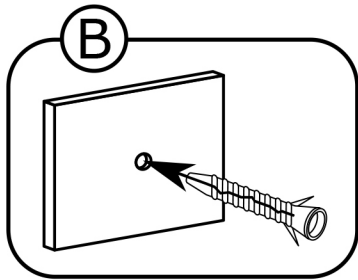
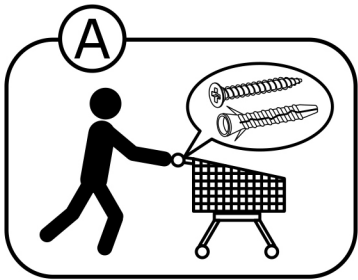
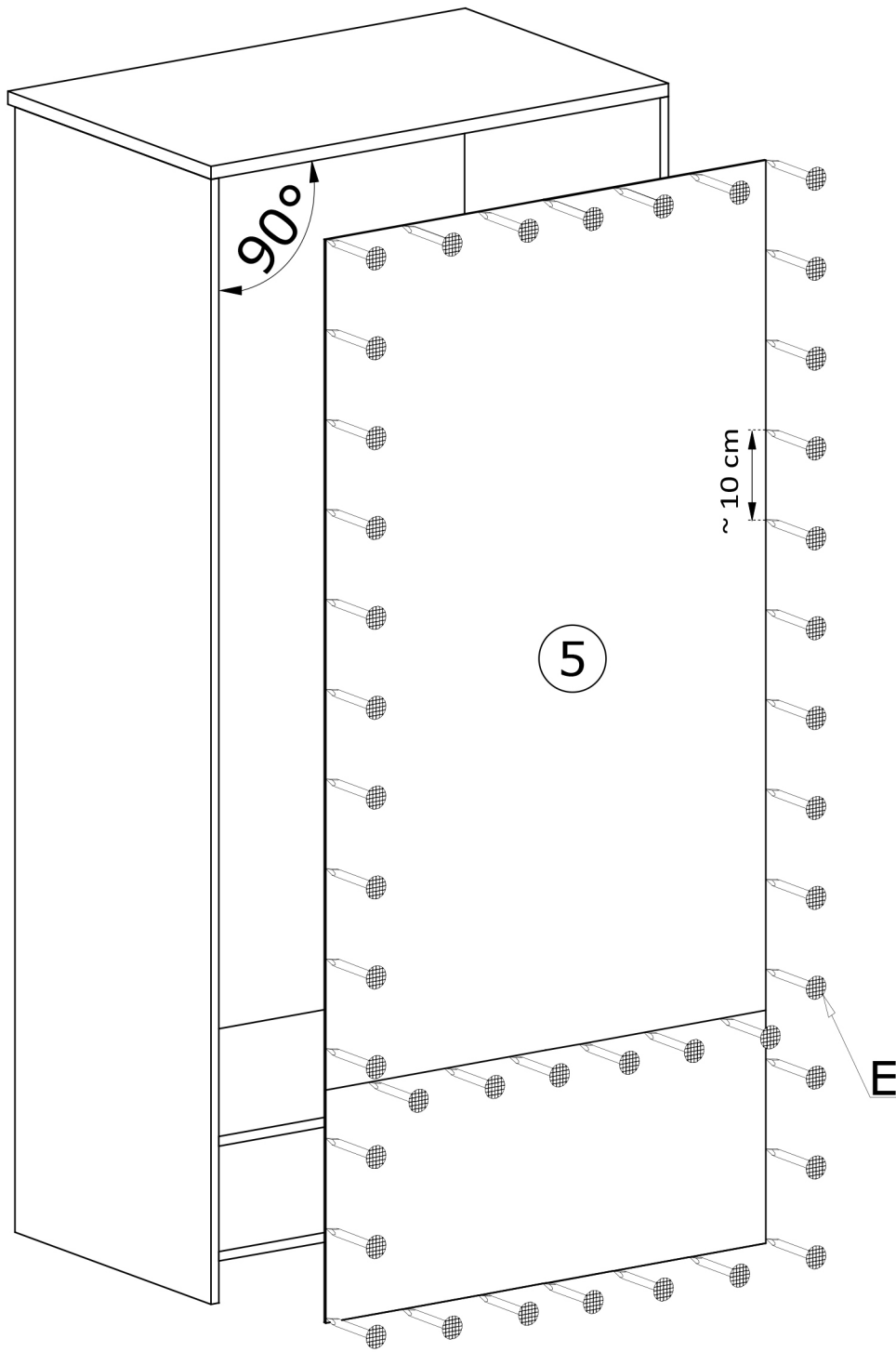

IV

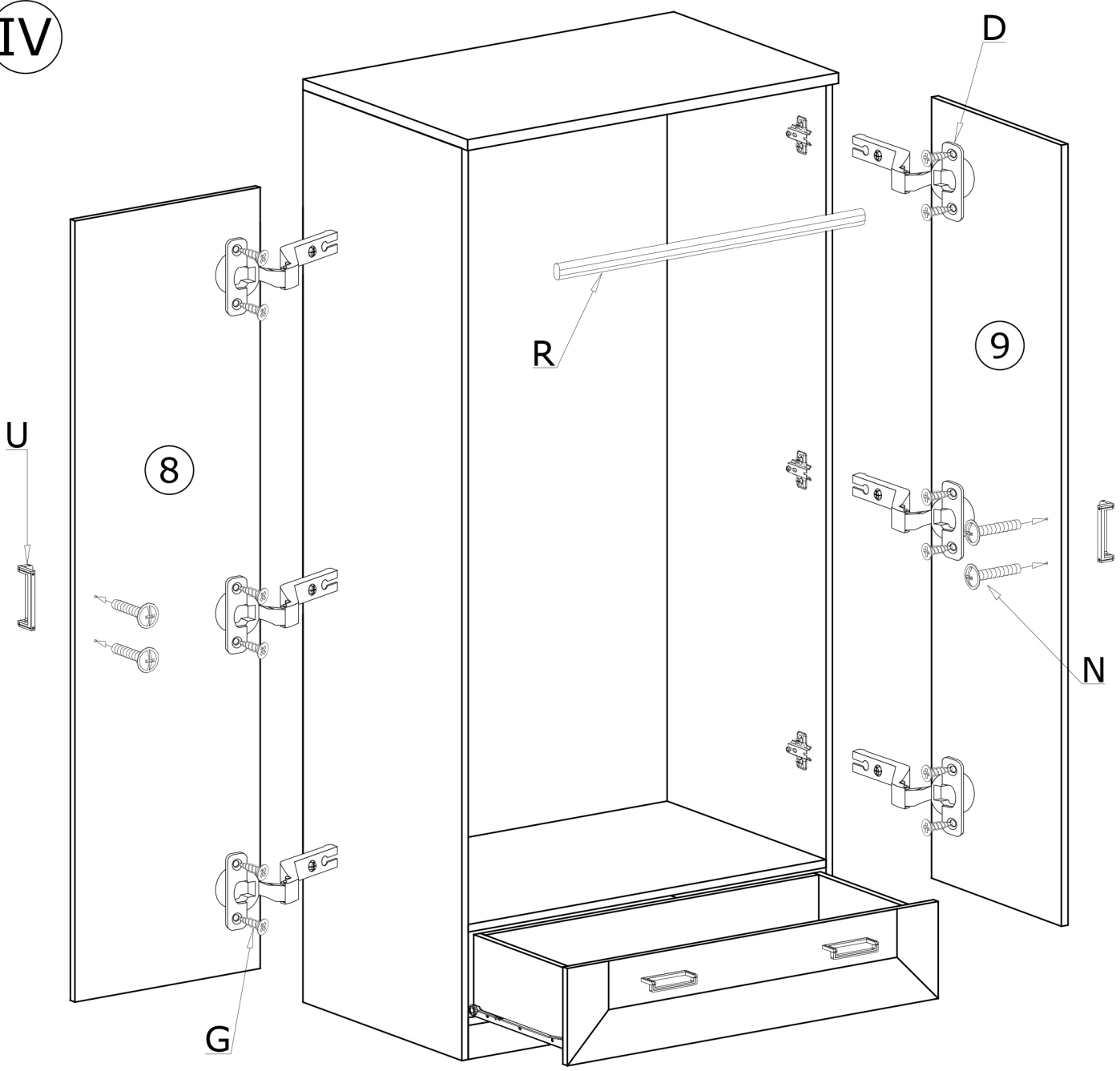

PL

**UWAGA!!!**

MONTOWANIE USZKODZONYCH ELEMENTÓW POWODUJE UTRATĘ GWARANCJI

**UWAGA!!!**

MEBEL ZAWIERA ELEMENTY DREWNIANE

W PRZYPADKU REKLAMACJI PROSZĘ PODAĆ NUMER PAKOWACZA ZNAJDUJĄCY SIĘ NA KARTONIE  
ODCIĘŃ DREWNA I UKŁAD SŁOI MOGĄ NIEZNACZNIE ODBIEGAĆ  
OD PREZENTOWANYCH NA ZDJĘCIACH KATALOGOWYCH

CZ

**UPOZORNĚNÍ!!!**

MONTÁŽ POŠKOZENÝCH KOMPONENTŮ RUŠÍ PLATNOU ZÁRUKU

**UPOZORNĚNÍ!!!**

NÁBYTEK OBSAHUJE DŘEVĚNÉ PRVKY

V PŘÍPADĚ REKLAMACE UVEĎTE PROSÍM ČÍSLO BALIČE, KTERÉ NAJDETE NA KRABICI  
ODSTÍN A KRESBA DŘEVA SE MOHOU VÝRAZNĚ LIŠIT  
OD TĚCH ZOBRAZENÝCH NA KATALOGOVÝCH FOTOGRAFIÍCH

DE

**BEACHTUNG!!!**

DER EINBAU BESCHÄDIGTER KOMPONENTEN SCHLIESST EINE GÜLTIGE GEWÄHRLEISTUNG AUS

**BEACHTUNG!!!**

MÖBEL ENTHALTEN HOLZELEMENTE

IM FALL EINER REKLAMATION GEBEN SIE BITTE DIE PAKETNUMMER AN,  
DIE SIE AUF DEM KARTON FINDEN  
HOLZSCHATTIERUNG UND HOLZZEICHNUNG KÖNNEN UNTERSCHIEDLICH  
VON DEN AUF DEN KATALOGFOTOS GEZEIGTEN ABWEICHEN

HR

**PAŽNJA!!!**

INSTALACIJA OŠTEĆENIH KOMPONENTI ZA POSLJEDICU IMA GUBITAK JAMSTVA

**PAŽNJA!!!**

NAMJEŠTAJ SADRŽI DRVENE ELEMENT

U SLUČAJU REKLAMACIJE, MOLIMO NAVESTI BROJ PAKIRANJA KOJI SE NALAZI NA KUTIJI  
NIJANSA DRVETA I RASPORED GODOVA MOGU MINIMALNO  
ODUDARATI OD ONIH NA KATALOŠKIM FOTOGRAFIJAMA

HU

**FIGYELEM!!!**

SÉRÜLT ALKATRÉSZEK BEÉPÍTÉSE ESETÉN A GARANCIA ÉRVÉNYÉT VESZTI

**FIGYELEM!!!**

A BÚTOROK FA ELEMÉKET TARTALMAZNAK

REKLAMÁCIÓ ESETÉN KÉRJÜK, ADJA MEG A DOBOZON TALÁLHATÓ CSOMAGOLÁSI SZÁMOT  
A FA ÁRNYALATA ÉS A CSOMÓK ELRENDEZÉSE  
JELENTŐSEN ELTÉRHET A KATALÓGUSBAN SZEREPLŐ KÉPEKTŐL

SK

**UPOZORNENIE!!!**

INŠTALÁCIOU POŠKODENÝCH KOMPONENTOV SA RUŠÍ ZÁRUKA

**UPOZORNENIE!!!**

NÁBYTOK OBSAHUJE DREVENÉ PRVKY

V PRÍPADE REKLAMÁCIÍ UVEĎTE ČÍSLO BALENIA NÁJDENÉ NA KRABICI  
ODTIEŇ DREVA A USPORIADANIE UZLOV  
SA MÔŽE VÝRAZNĚ LIŠIŤ OD KATALÓGOVÝCH OBRÁZKOV

SR

**PAŽNJA!!!**

MONTAŽA OŠTEĆENIH DELOVA DOVODI DO GUBITKA GARANCIJE

**PAŽNJA!!!**

NAMEŠTAJ SADRŽI DRVENE DELOVE

U SLUČAJU REKLAMACIJA MOLIMO DA DOSTAVITE PAKER BROJ KOJI SE NALAZI NA KARTONU  
NIJANSA BOJE DRVETA I RASPORED SLOJEVA MOGU NEZNATNO  
DA SE RAZLIKUJU OD PREZENTOVANIH NA SLIKAMA U KATALOGU